



INTIG 316/501 AC/DC

Inverter AC/DC Pulsed Argon Arc Welding Machine

OPERATOR'S MANUAL

(PLEASE READ CAREFULLY BEFORE OPERATION)

INTIG 316/501 AC/DC

Safety Depends on You

our arc welding and cutting equipment's are designed and built with ample safety consideration. However, proper installing and operating the machine can increase your safety.

DO NOT INSTALL, OPERATE OR REPAIR THIS EQUIPMENT CASUALLY WITHOUT READING THIS MANUAL THROUGHOUT.

Special Attention (Very Important):

- **PLACE THE MACHINE ON A PROPER PLANE, SO THAT THE MACHINE DOES NOT SLIP.**
- **PLEASE KEEP THE MACHINE AWAY FROM RAIN (UNDER PROPER ROOFING).**
- **READ THE INSTRUCTION MANUAL CAREFULLY BEFORE OPERATE THE MACHINE.**

Purchase Date : _____





Serial Number : _____

Machine Type : _____











Purchase Place : _____



Arc and arc rays can hurt.

	<p>1 Electric shock: The welding circuits are not insulated when welding. If you touch the two output electrodes of the machine with your bare skin at the same time, it will lead to electric shock, sometimes even fatal dangers. Users need to follow the items below to avoid electric shocks:</p> <ul style="list-style-type: none"> ■ If possible, lay some insulating materials, which are dry and large enough, in your working field. Otherwise, use the automatic or semiautomatic welding machine, DC welding machine as possible as you can. ■ Components in the automatic and semiautomatic welding machine such as the welding wire reel, feed wheel, contact tip and welding head are all electriferous. ■ Always be sure the machine has been connected perfectly to the work piece with the work cables and should be as close as possible to the working area. ■ The work piece should be grounded perfectly. ■ Make sure that the insulating material of the electrode holder, the grounding clamp, the welding cable and the welding head are not affected by damp, mildewed or spoilt, and be replaced momentarily. ■ Never dip the electrode in water for cooling. ■ Never touch electriferous parts of two welding machines at the same time, because this voltage is supposed to be two times of welding voltage while the grounding mode is not clear. ■ While working high above the ground or other places having the risk of falling, please be sure to wear safety belt to avoid losing balance caused by electric shock.
	<p>2 Arc: Use an arc welding mask to protect your eyes and skin from sparks and the rays of the arc, pay special attention to the filter glass, which must be conformable to the national standard.</p> <ul style="list-style-type: none"> ■ Use clothing made from durable flame-resistant material or sailcloth to protect your skin from hurting by the arc rays. ■ Remind other nearby personnel before working lest arc rays hurt them by accident.
	<p>3 Fumes and Gases: Welding may produce fumes and gases hazardous to health. Avoid breathing these fumes and gases. While working in limited room, use enough ventilation and/or exhaust to keep fumes and gases away from the breathing zone, or use the respirator. Do not weld at the same time when using of degreasing, cleaning or spraying operations. The heat and rays of the arc can react with these gases to form phosgene, a highly toxic gas.</p> <ul style="list-style-type: none"> ■ Some protective gases used in welding might displace the oxygen in the air, and can lead to hurt or even death. ■ Read and understand the manufacturer's instructions for this equipment, and validate the health certification of consumptive materials, make sure they are aseptis and innocuity.
	<p>4 Spatter: Spatter can cause fire or explosion.</p> <ul style="list-style-type: none"> ■ Remove fire hazards from the welding area. Remember that spatter from welding can easily go through small cracks and touch fire hazards. Keep the safety of all kinds of lines going though welding area, including hydraulic lines in the wild. ■ Where compressed gases are to be used in the field, special precautions should be used to prevent explosion. ■ When not welding, make certain that no electriferous part is touching the work piece or the work stage. Accidental contact can create a fire hazard. ■ Do not weld containers or lines, which are not proved to be innocuity. ■ It is very dangerous to heat, cut or weld tanks or containers at entry holes. Does not start work until the proper steps have been taken to insure that there are no flammable or toxic gases there. ■ Spatter might cause burn. Wear leather gloves, heavy shirt, cuffless trousers, high shoes and a cap over your hair to prevent from burning by spatter. Wear the ear shield when performing sideways or face up welding. Always wear safety glasses with side shields when being in a welding area. ■ The welding cables should be as close to the welding area as possible, and the short, the better. Avoid welding cables going through the building framework, lifting chains, AC or DC cables of other welding machines and appliances. The welding current is strong enough to damage them while having short circuit with them.
	<p>5 Cylinder: Damage of it might cause explosion.</p> <ul style="list-style-type: none"> ■ Make sure that the gas in the storage cylinder is qualified for welding, and the decompression flowmeter, the adapter and the pipe are all in good condition. ■ Make sure that the installation of cylinder is by the wall and bundled tightly by a chain. ■ Be sure to put the cylinder in the working space with no crash or shake, and far from welding area. ■ It is forbidden to touch cylinder with the welding clamp or the work cables. ■ Avoid facing the cylinder while installing the decompression flowmeter or the gasometer. ■ When not working, please tighten the valve.

INTIG 316/501 AC/DC

	<p>6 Power: (For electrically powered welding and cutting equipment) Turn off input power before installation, maintenances and repair, so that avoid accident.</p> <ul style="list-style-type: none"> ■ Huanyuan welding equipment is I class safeguard equipment; please install the equipment by manufacture's professional person ■ Ground the equipment perfectly in accordance with the manufacturer's recommendations.
	<p>7 Power:(For engine driven welding and cutting equipment)</p> <ul style="list-style-type: none"> ■ Work in ventilated place or outdoors.
	<ul style="list-style-type: none"> ■ Do not add fuel near to fire or during engine starting or welding. When not working, add fuel after engine is cooling down; otherwise, the evaporation of hot fuel would result in dangers. Do not splash fuel out of the fuel tank, and do not start the engine until complete evaporation of the outside fuel.
	<ul style="list-style-type: none"> ■ Make sure that all the safeguard equipment's, machine cover and devices are all in a good condition. Be sure that arms, clothes and all the tools do not touch all the moving and rotating components including V belt, gear and fan etc. ■ Sometimes having to dismantle some parts of the device during maintenance, but must keep safety awareness strongly every time. ■ Do not put your hand close to fans and do not move the brake handle while operating. ■ Please remove the connection between the engine and the welding equipment to avoid sudden starting during maintenances.
	<ul style="list-style-type: none"> ■ When engine is hot, it is forbidden to open the airtight cover of the radiator water tank to avoid hurt by the hot vapor.
	<p>8 Electromagnetic: Welding current going though any area can generate electromagnetic, as well as the welding equipment itself.</p> <ul style="list-style-type: none"> ■ Electromagnetic would affect cardiac pacemaker, the cardiac pacemaker users should consult one's doctor first. ■ The effect of electromagnetic to one's health is not confirmed, so it might have some negative effect to one's health. ■ Welders may use following method to reduce the hazardous of electromagnetic: <ol style="list-style-type: none"> a. Bundle the cable connected to the work piece and the welding cable together. b. Do not unwind partially or entirely your body with the cable. c. Do not place yourself between the welding cable and the ground (work piece) cable, if the welding cable is by your left side, then the ground cable should be by your left side too. d. The Welding cable and the ground cable are as short as possible. e. Do not work near to the welding power source.
  	<p>9 Lift equipment: carton or wooden boxes package the welding machines supplied by Warpp Engg. There is no lifting equipment in its wrapper. Users can move it to the prospective area by a fork-lift truck, then open the box.</p> <ul style="list-style-type: none"> ■ If their are rings, the machine can be transited using rings. While our Welding Machine Manufacture reminds users, there is possible risk to damage the welding machine. It is better to push the welding machine moving in use of its rollers unless special situations. ■ Be sure that the appurtenances are all removed off when lifting. ■ When lifting, make sure that there is no person below the welding machine, and remind people passing by at any moment. ■ Do not move the hoist too fast.
	<p>10 Noise: our Welding Machine Manufacture reminds users: Noise beyond the limit (over 80 db) can cause injury to vision, heart and audition depending on oneself. Please consult local medical institution. Use the equipment with doctor's permission would help to keeping healthy.</p>

INTIG 316/501 AC/DC

1. Features and Usage	5
2. Working Conditions and Environment:	5
3. Technical specification	6
4. Product System Introduction	6
5. Product Construction Introduction	7
6. Installation	13
7. Operation Introduction	14
8. Trouble shooting	18
9. Packing list and appendix	21
10. INTIG 316 AC/DC electric schematic	22
11. INTIG 501 AC/DC electric schematic	23
12. Welding machine Picture's	24
13. Spare parts List for INTIG 316, 501 AC/DC	26

INTIG 316/501 AC/DC

1. Features and Usage:

INTIG AC/DC series pulsed TIG welding machine has the function of DC TIG welding, DC pulsed TIG welding, AC TIG welding, and AC pulsed TIG welding. It is a kind of tungsten TIG welding machine incorporated multi-function.

The primary inverter of INTIG AC/DC series pulsed TIG welding machine adopts the latest IGBT and fast recovery diode etc , the invert frequency is 20KHZ. The small mid-frequency transformer replaced the heavy industrial frequency transformer, which has the advantages of high efficiency, low no-load loss, stable current, energy saving, material saving and high reliability etc..

The secondary inverter of INTIG AC/DC series pulsed TIG welding machine adopts the half-bridge inverter circuit, which has advantages like adjustable frequency and pulse width , good reliability and energy saving etc

INTIG AC/DC series pulsed TIG arc welding machine has all functions required for welding technique. The functions like high frequency arc striking, gas pre-flow (adjustable), initial current (adjustable), current upslope (adjustable), current down slope (adjustable), crater current (adjustable), gas post-flow etc are available in the machine. During the AC TIG welding the cleaning action of welding is adjusted by AC WAVE BALANCE and also AC frequency is adjustable which is useful to control the bead of the welding. The machine can be used for ordinary welding as well as pulsed welding. The advantage of the pulsed welding is variation in the high and low welding current, better arc stiffness due to the electromagnetic pinch effect, the melting time for the metal is short, so the weld seam is much more fine with higher strength. The form of weld seam surface could also be changed through changing the four pulse parameters, so it could also decided by welding machine.

This welding machine can mainly used for all metals like aluminum, magnesium, copper, stainless steel on pipe, boiler, aviation, etc.

2. Working Conditions and Environment:

1. Input power

1.1 The exact input voltage wave shape should be sine wave, the frequency fluctuation should be no more than $\pm 1\%$ of the rated value.

1.2 The fluctuation of input voltage must be within 380 to 440 VAC.

1.3 Imbalance between phase should not exceed 5%.

2. Environment:

A. Ambient temperature ranges:

Welding temperature range: $-10^{\circ}\text{C} \sim +40^{\circ}\text{C}$

Transportation and Storage temperature range: $-25^{\circ}\text{C} \sim +55^{\circ}\text{C}$

B. Operating area must be dust free for better usage of the machine.

C. Operating altitudes: less than 1000m

D. Wind speed should be no more than 1m/s

E. Avoid exposing the machine to direct sunlight and rain.

3. Technical Specification:

Model Parameter	INTIG 316 AC/DC	INTIG 501 AC/DC
Input power	380 - 440 vac 50 / 60 Hz	
Rated input capacity(KVA)	11.9	21

INTIG 316/501 AC/DC

Rated input current(A)		18.2	31.8
Open circuit voltage(V)		82	85
Rated welding current(A)		315	500
Rated welding voltage(V)		22.6	30
Rated duty cycle(%)		60%	60%
Gas pre-flow time(S)		0.0 ~ 5.0	
Initial current adj. range(A)	AC	20 ~ 315	20 ~ 500
	DC	10 ~ 315	10 ~ 500
Current upslope time(S)		0.0 ~ 10.0	
Welding current adj. range(A)	AC	20 ~ 315	20 ~ 500
	DC	10 ~ 315	10 ~ 500
Peak current adj. range(A)	AC	20 ~ 315	20 ~ 500
	DC	10 ~ 315	10 ~ 500
Pulse frequency(Hz)		0.2 ~ 99.9	
PWM ratio(%)		10% ~ 90%	
Base current adj. range(A)	AC	20 ~ 315	20 ~ 500
	DC	10 ~ 315	10 ~ 500
AC frequency(HZ)		20 ~ 200	
Clean width(%)		10% ~ 50%	
Current down-slope time(S)		0.1 ~ 15	
Crater current adj. range(A)	AC	20 ~ 315	20 ~ 500
	DC	10 ~ 315	10 ~ 500
Gas post-flow time(S)		0.0 ~ 20.0	
Dimension(L×W×H)(mm)		705×350×650	725×385×785
Weight(kg)		52	70

4. Product System Introduction**a) Working principle**

INTIG AC/DC series pulsed TIG welding machine adopts AC-DC-AC-DC-AC double inverter circuit. The primary inverter takes IGBT as the inverter main component. After the three-phase AC input power is rectified through three phase Bridge rectifier, it is supplied to IGBT inverter, and inverted at 20KHz AC. This is given as input to main transformer, which steps down the voltage. Output of main transformer given to fast recovery diode and filter for rectification. Rectified DC is given to secondary inverter section to drive AC output. Which is used for AC TIG welding operation.

The control circuit controls the output current through pulse width modular. The negative feedback signal coming from Hallsensor is amplified, then it is fed to negative input end of error amplifier from special PWM circuit, then it controls the conduction time of IGBT, so that the output current can be kept at required level.

The secondary inverter uses IGBT as the main inverter component, changes the DC current to AC square wave current, then the square wave required by AC TIG welding is obtained.

This machine has functions of gas preflow, gas postflow, HF arc striking, current upslope, current down slope. All these functions are controlled by the digital signal programming.

b) Working circuit diagram:

INTIG 316/501 AC/DC

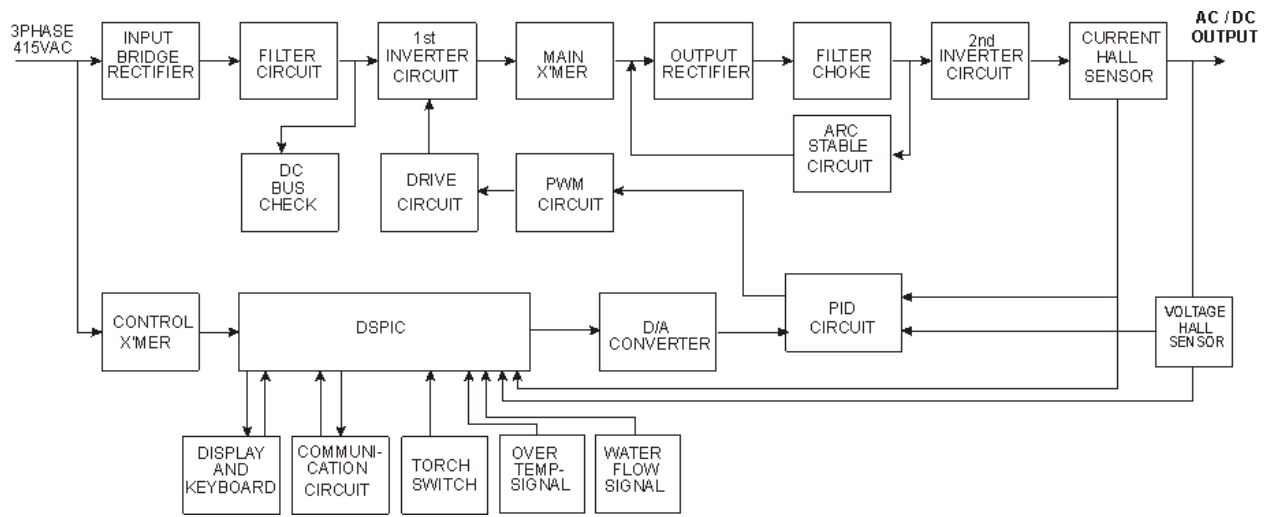

5. Product Construction Introduction

1).Front panel description and function:

The front panel is divided into six areas according to the function:

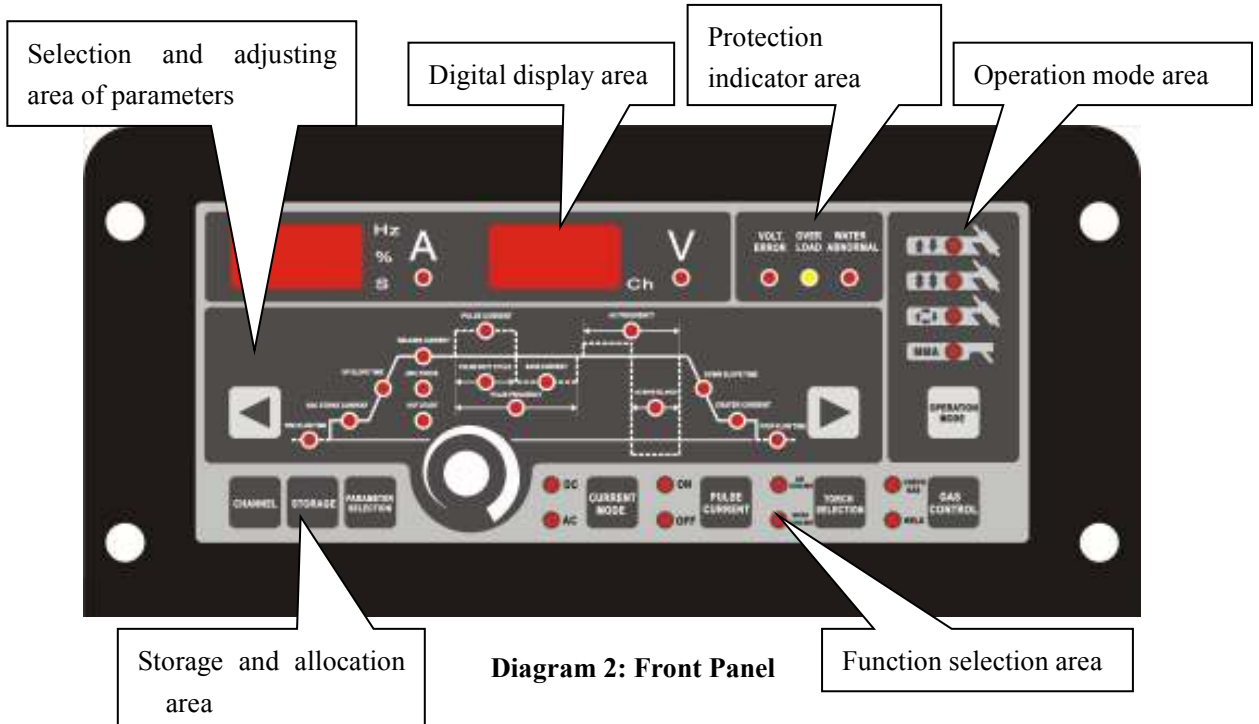

2).Digital display area:

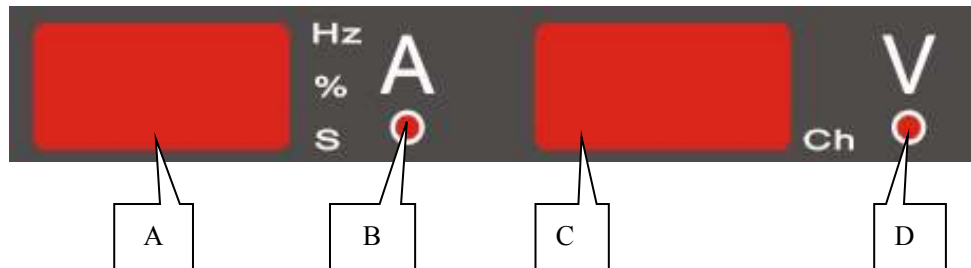

A. 1st digital display meter: it is used to display welding/preset current, pulse/AC frequency, pulse width ratio/clean width, pre-gas time etc.

B. Indicates unit of the parameter being selected.

C. Indicates what second display is showing.

3).Selection and adjusting area of parameters :

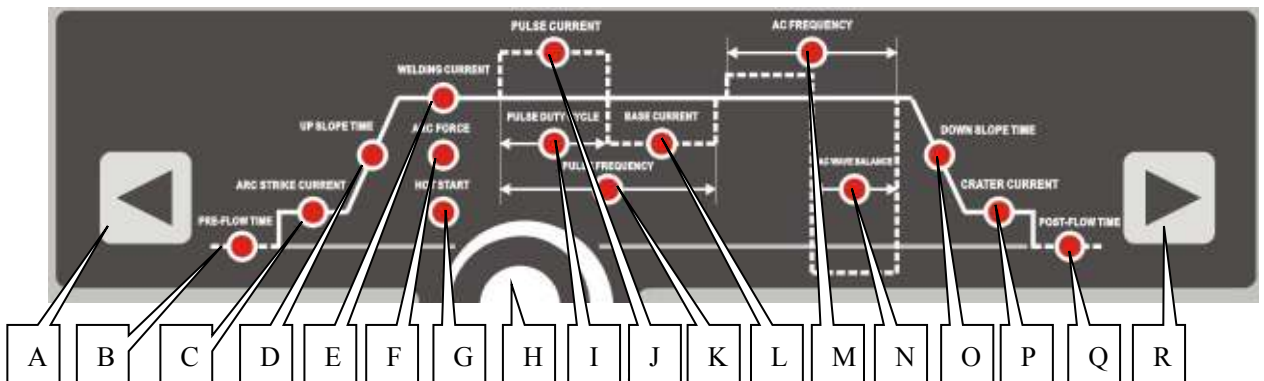

INTIG 316/501 AC/DC

At the time, there is only one indicator is on in this area, which indicates current displayed& adjusted parameter, and the parameter value is displayed on 1st digital display meter, adjusted by encoder. When there is no pulse during working, the welding current is displayed. When there is pulse during working, the peak current is displayed. The current displayed or adjusted parameter can be selected through pressing the left or right selection key.

- A. Left selection key: press the key, the lighted parameter indicator will move to left, it moves one after press key one time.
- B. Preflow time: adjusting the prflow time.
- C. Arc striking current: it is the current when the arc is started.
- D. Upslope time: current is transited from arc striking current to welding current(when there is no pulse)/peak current and base current (when there is pulse)time.
- E. Welding current: it is the current when there is no pulse working.
- F. Arc force: under the MMA status
- G. Hot start:under the MMA status
- H. Peak current: it is pulsed peak current when there is pulse working.
- I. Rotary encoder: it is used to adjust current displayed parameter.
- J. PWM ratio: when there is pulse working, the ratio between peak current time and pulse cycle.
- K. Pulse frequency: when there is pulse selected, it is pulsed working frequency (the inverse of pulse cycle).
- L. Base current: when there is pulse selected, it is the base current of pulse.
- M. AC frequency: during AC welding, adjusting the current frequency.
- N. Clean width: when it is AC welding, adjusting the width ratio of current negative half-wave, and clean width of negative pole.
- O. Down-slope time: the time of current transited from welding current(no pulse)/peak current and base current(with pulse) to crater arc current.
- P. Crater arc current: the current during the arc ending.
- Q. Gasflowt time: it is gas-postflow time.
- R. Right selection key: press the key, the lighted parameter indicator will move to right, it moves one after press key one time.

4).Function selection area:

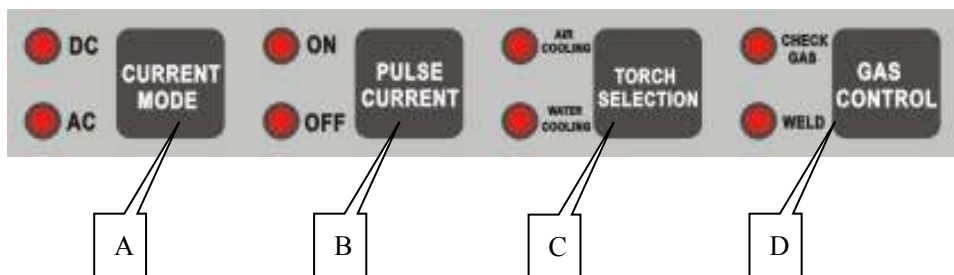

- A. Current mode selection key and indicator: select the output current mode(DC/AC).
- B. Pulse current key and yes or no indicator: select the current with pulse or without pulse.
- C. Welding torch selection key and indicator: when the gas cooling torch is chosen, this switch should be in gas cooling operation. When the water cooling torch is chosen, this witch should be in water cooling operation, and water pressure checking function is started.
- D. Gas control selection key and indicator: before welding it is in the position of gas checking. Adjusting the argon flow, after adjusting, when the switch WELD position, the welding machineswitch ON gas valve and cut off it automatically.

5).Operation mode area :

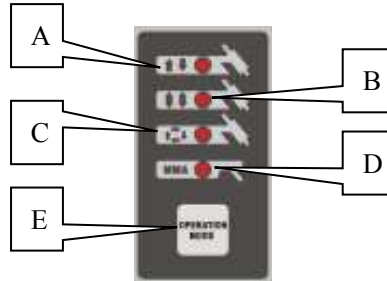

- A. Non self-lock: when this indicator is on, the welding machine is the non self-lock status of TIG welding.
- B. Self-lock: when this indicator is on, the welding machine is the self-lock status of TIG welding.
- C. Repetition: when this indicator is on, the welding machine is the repeated non self-lock status of TIG welding.
- D. MMA: when this indicator on, the machine is under MMA status
- E. Operation mode selection key: this key is used to switch the operation modes of welding machine.

6).Storage and allocation area :

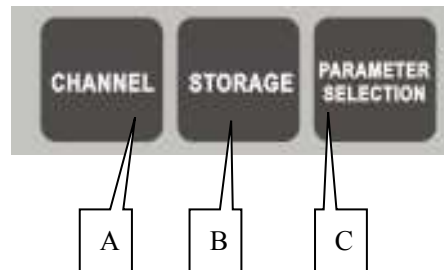

- A. Pass key: when it is the 1st time to press this Pass key, voltmeter displays current pass no., and ammeter displays current storage welding parameters. The left selection key or right selection key can be pressed to display other parameters stored inside the pass. The storage key can be pressed to store the current welding parameter into current pass. The allocation key can be pressed to allocate the storage parameter inside pass as current welding parameter. The pass key can be pressed to choose next pass. If no key is pressed, it will back out from the pass.
- B. Storage key: have current welding parameter stored inside current pass.
- C. Allocation key: have current parameter which is stored inside the pass allocated out to use as current welding parameter.

8). Protection indicator area:

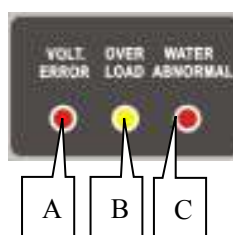

INTIG 316/501 AC/DC

- A. Grid voltage abnormality indicator: when the input voltage is not within 380-440 vac or lacks phase, this indicator is on.
- B. Overload indicator: when the ambient temperature is too high, or the machine is used over the rated duty cycle, which causes the overheat inside machine, this indicator is on.
- C. Water cooling abnormality indicator: when the water cooling torch is used, it shows the water pressure status. When the water pressure is enough, the indicator is off, when the water pressure is not enough, the indicator is on.

9). Back panel picture and introduction:

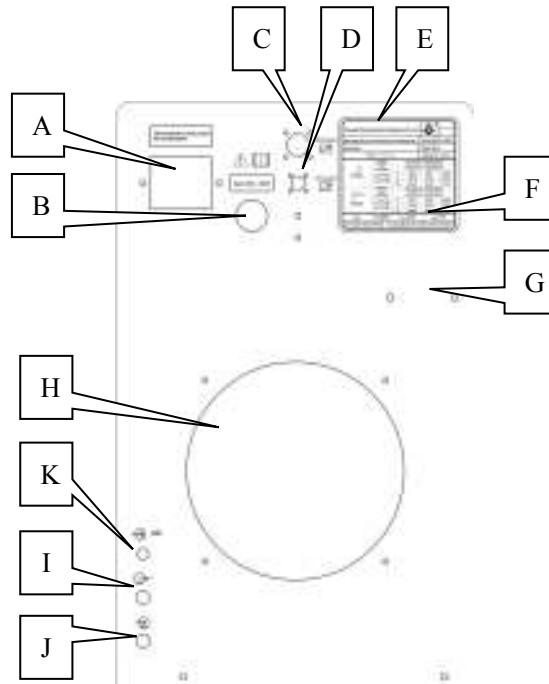

- A. Power protection switch: it only used for protection of the over load current.
- B. Power input cable: the three phase input cable is fixed on the machine through the screw connector.
- C. Communication interface A: it connects the pedal controller (INTIG 316 AC/DC) or the same frequency communication interface of double machine (INTIG 501 AC/DC).
- D. Communication interface B: it connects wireless controller.
- E. Silk print place of name plate.
- F. Label place for welding machine series no..
- G. Installation place of wireless controller.
- H. Cooling fan.
- I. Water-returning connector.
- J. Water inlet connector.
- K. Gas inlet connector: it connects argon relieve valve.

10).Front below panel introduction:

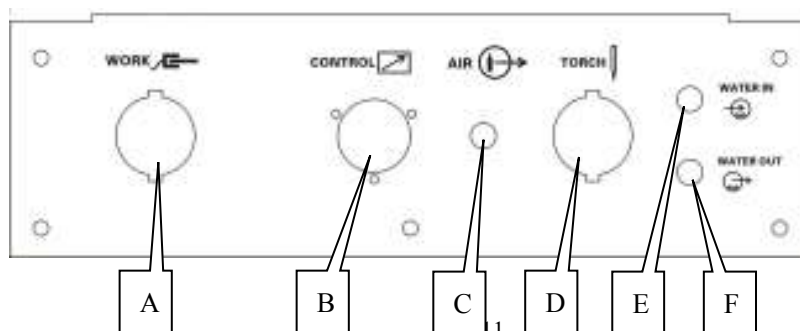

INTIG 316/501 AC/DC

- A. Connect workpiece.
- B. Connect the plug of welding torch switch.
- C. Argon output mouth.
- D. Connect welding torch.
- E. Connect water-returning mouth of water cooling torch.
- F. Connect water-output mouth of water cooling torch.

Preparation before welding

1.Input power capacity and connecting cable:

The input power of this machine is 3 phases, 415V, 50/60HZ. Customer should have the related electricity cabinet and install the automatic breaker and earth cable. Please connect the green and yellow earth cable on the machine back with the protection earth cable on electricity cabinet, the outer cable should not be less than the following table value.

Model \ Value	Section surface of input cable(mm ²)	Breaker capacity(A)	Section surface of earth cable(mm ²)
INTIG 316 AC/DC	≥6	40	≥6
INTIG 501 AC/DC	≥6	60	≥6

If the electricity generator is used for power supply, then the capacity of all the generators and compensation cables should be 3 to 5 times of power source.

2.Electricity-usage safety

- L. As to the following situations, the input power source must be cut off by the switch of the electricity distribution cabinet.
 - . When there is need to contact input or output terminals of power source, or open the machine cover for interior examination.
 - . When there is need to check welding torch of exchange spare parts.
 - . When there is no need to use welding machine.
- M. For avoiding electricity shock, please make sure if it is earth-connected reliably.
- N. The damaged cables must be replaced.
- O. When operating in the moist field or connecting mother-material cables, the dry working clothes, fur gloves and rubber safety shoes must be worn.

3.ventilation

Dusts and harmful gas are produced in the welding process; the welding area have proper ventilation .

4.Protection from arc

The strong arc is produced in the welding process, so the welding shield mask with filter glass must be used during the welding process. Additionally, the neck, face and hands should be protected from the damages of arc and metal splash.

Filter glass selection

Welding current	Below 100A	100A-300A	300A-500A
Filter glass class	9 or 10	11 or 12	13 or 14

5.burning

In order to avoid metal splash and ray-heat radiation produced in the welding process, the working clothes and fur gloves should be worn, as well as pay attention to protect face, neck, arms and legs. The protection barrier should be installed around the welding fields, to avoid the splash melt burning people around.

6.Fire

The melted metals with high temperature may splash around during the welding process, so the following

INTIG 316/501 AC/DC

items must be paid attention to:

- The flammable matters must be far away from the welding site.
- Before welding, check if there are flammable matters in the operation range or not, in order to take them away for eliminating hidden troubles.

6. Installation

1. Installation location

The location conditions should follow the items below and the distance between the machine and the wall or the other machines should be at least 30cm.

- Keep the machine away from direct sunlight, rain and dusty atmosphere.
- The floor must be massive and flat, such as cement floor.

2. Exterior connection

- A fuse breaker or a breaker without fuse must be set at the input side of each welding machine.
- Before connecting, the switch OFF the electricity distribution box.
- Have the fast connector of earth cable connected to output + terminal of welding machine, and the other end of cable is connected to workpiece properly.
- Have the fast connector of torch cable connected – terminal, and the gas inlet nut of the torch to the gas outlet of the machine. The water inlet pipe of the torch connects with the water outlet connector of the machine; the water outlet pipe of the torch connects with the water backward of the machine.

Warning: the fast connector must be connected tightly, or else it may produce heat may damage connector.

- Argon flow meter

Argon flow meter is the exclusive flow regulator for argon, which cannot be used for the other high pressure gas. It is not allowed to disassemble the argon flow meter.

Additionally, it is not allowed to touch the pressure adjusting devices and screws inside the meter. Otherwise, fatal accidents may happen.

- The water inlet mouth of welding machine is connected with the water output mouth of recycling water cooler, the water-returning mouth of welding machine is connected with water-returning mouth of recycling water cooler.

Notice: For this series welding machines, water cooling unit is outside the power source, when using water cooled torch connect torch as per below diagram. (picture 4)

Picture 4 : Installation Diagram

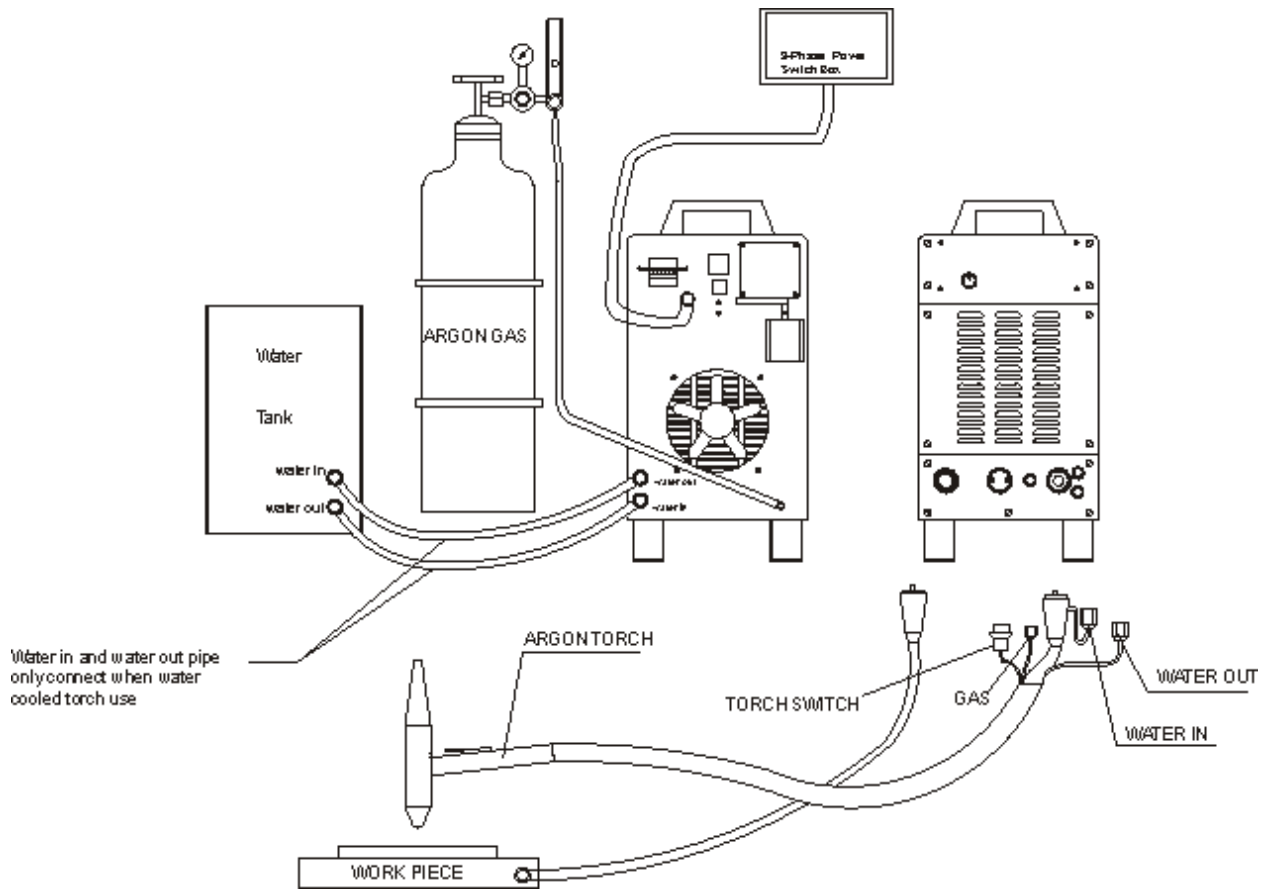

7.Operation Introduction

1. Turn on the power source, the welding machine proceeds self-check, the digital display meters and all indicators on the panel will be on for 1.5s, and goes off for 0.5s, then the display will be normal.
2. Press the gas control key, the indicator of gas checking is on. As per requirement, adjust the argon flow, then press the gas control key again, then indicator of weld is on.
3. Select the current mode according to the welding material. Choose AC welding for Aluminum, Magnesium and their alloy, while choose DC welding for carbon steel.
4. As per requirement set pulse on/pulse off, and press the pulse current key to set.
If pulse off mode selected , adjust encoder to set the welding current.
If pulse on mode selected , set the peak current, pulse width ratio, pulse frequency, base current, press left selection key or right selection key to select the parameters to set.
5. When the AC welding is selected, as per requirement set the AC frequency and clean width.
6. As per requirement, set gas pre-flow time, initial current, up-slope time, down-slope time, arc crater time, gas post flow time.
7. Welding operation sequence
 - a) Non self-lock
Keep the tungsten 1 ~ 3mm from workpiece, then press the torch switch , after the current up slopes the normal welding starts, after finishing welding release the torch switch, the current down slopes to

INTIG 316/501 AC/DC

crater arc current and then it is off. After finishing welding please do not take the welding torch away immediately, until the postponed gas flow time is ended, so that the molten pool and tungsten could be better protected.

b) Self-lock

Keep the tungsten 1 ~ 3mm from workpiece, then press the torch switch to strike arc. After the arc strikes, keep the striking arc current, and find the welding position, release the torch switch, the current will up slope to the preset value, the welding begins. Press the torch switch again when you want to finish the welding, the current will down slope to crater arc current, then release the switch, the arc will off, the welding finishes. After finishing welding please do not take the welding torch away immediately, until the postponed gas flow time is ended, so that the molten pool and tungsten could be better protected.

c) Repetition

Keep the tungsten 1 ~ 3mm from workpiece, then press the torch switch to strike arc. After the arc strikes, keep the striking arc current, and find the welding position, release the torch switch, the current will up slope to the preset value, the welding begins. Press the torch switch again, the current will down slope to crater arc current, then release the switch, the current is increased to welding current. Above process is repeated. When it is ready to finish welding, lift up the torch and cut off arc, the welding is finished. After finishing welding please do not take the welding torch away immediately, until the postponed gas cut-off time is ended, so that the molten pool and tungsten could be better protected.

Operation

1. Warning

To avoid shock, the following items should be complied with:

- ✧ The fatal shock or burnt accident can be caused if touching the electrified parts.
- ✧ It is prohibited to touch the tungsten electrode when press the switch of torch
- ✧ Before replacing the tungsten electrode, the input power must be cut off.
- ✧ Dry working clothes and gloves must be worn when operating.

Security operating instruction

- ✧ The contents of the manual must be understood adequately, the machine must be operated by the professionals with security operation knowledge and skill.
- ✧ The machine must be used under the rated duty cycle. If the duty cycle exceeds the rated value, the machine may be burnt.
- ✧ The following items should be complied with during the operation process.
- ✧ Change the appropriate electrode when it is difficult to strike arc.
- ✧ If it is difficult to strike arc, please check the flow of shield gas

2. AC TIG welding

The following items should be pay attention when the machine is used in AC TIG welding mode.

- ✧ The unnecessary prolong cable is no use, it should be as short as possible.
- ✧ When use prolong cable , it is better to enlace the mother-material cable and the torch cable, bundle insulating tape and pull as straightly as possible.

3. AC frequency :

- ✧ Output frequency should be freely set between 20HZ ~ 100HZ
- ✧ The higher the frequency, the more centralize of the arc terminal.
- ✧ The higher the frequency, the shallower of the melt depth, the less of the deposition.
- ✧ The higher of the frequency, the less consumption of the electrode, tungsten electrode is suggested to use

INTIG 316/501 AC/DC

AC wave balance

- When use AC TIG welding for aluminum, the clean strength of the arc negative can be adjusted through the clean width knob.
- The relationship between the knob set position of clean width knob, welding performance and tungsten consumption is as below:

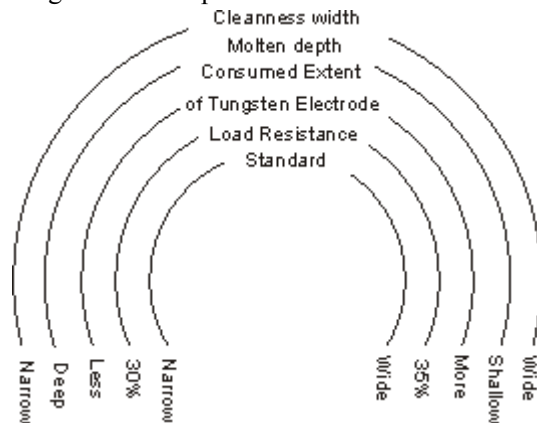

- Note: Although the rated duty cycle of the machine is 35%, when use AC TIG welding, if the clean width set to “narrow” position, please use the machine under 35% duty cycle.

Exchange frequency and DC rate

- When use TIG welding for aluminum, use AC and DC together can ensure the clean width as well as reduce the tungsten burnt.

TIG welding (only for reference)

Normal TIG welding (without pulse)



Material	Thickn ess (mm)	Diameter Of electrode (mm)	Diameter Of Welding wire (mm)	Current (A)	Argon flow (L/min)	Layer	Groove
Stainless Steel (DC positive)	0.6	1.0,1.6	~ 1.6	20 ~ 40	4	1	a.b
	1.0	1.0,1.6	~ 1.6	30 ~ 60	4	1	a.b
	1.6	1.6,2.4	~ 1.6	60 ~ 90	4	1	b
	2.4	1.6,2.4	1.6 ~ 2.4	80 ~ 120	4	1	b
	3.2	2.4,3.2	2.4 ~ 3.2	110 ~ 150	5	1	b
	4.0	2.4,3.2	2.4 ~ 3.2	130 ~ 180	5	1	c.d
	4.8	2.4,3.2,4.0	2.4 ~ 3.2	150 ~ 220	5	1	c.d
Desoxy -copper (DC positive)	0.6	1.0,1.6	~ 1.6	50 ~ 70	3 ~ 4	1	a.b
	1.0	1.6	~ 1.6	60 ~ 90	3 ~ 4	1	a.b
	1.6	2.4	1.6 ~ 2.4	80 ~ 120	3 ~ 4	1	b
	2.4	2.4,3.2	2.4 ~ 3.2	110 ~ 150	4	1	b
	3.2	3.2,4.0	3.2 ~ 4.8	140 ~ 200	4 ~ 5	1	c
	4.0	3.2,4.0,4.8	4.0 ~ 4.8	180 ~ 250	4 ~ 5	1	c.d
	4.8	4.0,4.8	4.8 ~ 6.4	250 ~ 300	5 ~ 6	1	c.d
Aluminum (AC)	0.6	4.0,4.8,6.4	4.8 ~ 6.4	300 ~ 400	5 ~ 6	1-2	c.d
	1.0	1.6	~ 1.6	50 ~ 60	5 ~ 6	1	a.b
	1.6	1.6,2.4	~ 1.6	60 ~ 90	5 ~ 6	1	a.b
	2.4	1.6,2.4	1.6 ~ 2.4	80 ~ 110	7	1	b
	3.2	2.4,3.2	2.4 ~ 4.0	100 ~ 140	6 ~ 7	1	b
	4.0	3.2,4.0	3.2 ~ 4.8	140 ~ 180	7 ~ 8	1	b
	4.8	3.2,4.0,4.8	4.0 ~ 6.4	170 ~ 220	7 ~ 8	1	b
Magnesium	6.4	4.0,4.8	4.0 ~ 6.4	200 ~ 270	8 ~ 12	1-2	c.d
	1.0	1.6	~ 1.6	30 ~ 40	3 ~ 4	1	a.

INTIG 316/501 AC/DC

(AC)	1.6	1.6,2.4	1.6 ~ 2.4	40 ~ 70	4 ~ 5	1	b
	2.4	1.6,2.4	1.6 ~ 2.4	60 ~ 90	4 ~ 5	1	b
	3.2	1.6,2.4	3.2 ~ 4.2	75 ~ 110	5 ~ 6	1	b
	4.0	2.4,3.2,	3.2 ~ 4.0	90 ~ 120	5 ~ 6	1	c,d
	4.8	3.0,1.4	4.0 ~ 4.8	110 ~ 150	5 ~ 6	1	c,d
	6.4	3.2,4.0	4.0 ~ 4.8	130 ~ 170	6 ~ 7	1-2	c,d

DC pulse TIG welding

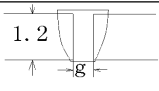
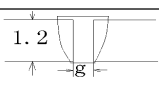

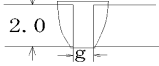
◆ Flat welding, butt welding

Material	Shape of joint	Seam width (mm)	Pulse				Welding speed (cm/min)	Wire feed speed (cm/min)
			Pulse current (A)	Based current(A)	Pulse frequency(Hz)	Pulse width (%)		
Soft steel		0	200	50	2.5	50	60	60
		1.2	150	20	1.5	45	30	60
		1.6	130	20	1	50	15	40
Stainless steel		0	150	50	3	50	80	40
		1.2	150	20	1	35	17	40
		1.6	130	20	0.8	30	10	40
		2.0	130	2	0.8	30	83	0
Copper		0	280	50	3	50	80	75
		1.2	280	50	2	50	50	75
		1.6	280	30	1.5	40	25	
Titanium		0	200	100	1	30	25	0

Shielded gas: argon (10 L/min) Electrode: thorium tungsten electrode (3.2 mm)

Welding wire: diameter 1.2 mm Length of arc: 2 mm

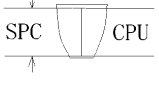
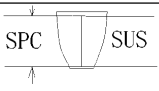
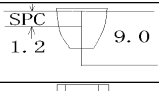
◆ welding for different thermal capacity joint connector

Material	Shape of joint	Seam width (mm)	Pulse				Welding speed (cm/min)	Wire feed speed (cm/min)
			Pulse current (A)	Based current(A)	Pulse frequency (Hz)	Pulse width (%)		
Soft steel + steel		1	250	50	0.8	20	10	60
Stainless steel + Soft steel		1	170	60	2.5	50	50	60
Soft steel		1	120	50	2	50	20	30
Stainless steel		1	160	50	1.5	45	8.5	30



Protection gas: argon(10L/min) electrode: tungsten electrode(2 . 4 mm)

Fillet wire dia.:1.2mm arc length:2 ~ 3 mm

A. AC pulse TIG welding

Material	Shape of joint	Thickne ss (mm)	Pulse				Welding wire	
			Pulse current(A)	Based current(A)	Pulse frequency (Hz)	Pulse width (%)	Diameter (mm)	Wire feed speed (cm/min)

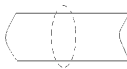
INTIG 316/501 AC/DC

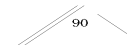
Aluminum		1.0	70	25	1	50	1.6	75
		1.5	80	40	1	50	1.6	95
		1.5	90	25	1	50	1.6	75
		1.5	85	25	1	50	1.2	95
		3.2	170	25	1	50	1.2	290
		3.0	170	25	1	50	1.6	170
		6.0	220	25	1	50	1.6	250
		6.0	180	25	1	50	1.6	
		6.0	180	25	1	50	1.6	250
		6.0	180	25	1	50	1.6	250
		3.2	170	25	1	50	1.6	290
		6.0	220	25	1	50	1.6	270
		3.0	120	25	1	50	1.6	60

4. Maintenance

In order to use safely, periodical maintenance and repair should be carried out. When examining the interior and exterior connection ends, the primary distribution box must be cut off. (or take the fuses away)

a. Daily Notices

- (1) There are abnormal vibration, sound, smell or not;
- (2) There are abnormal heat at the cable connection or not;
- (3) When the switch of power source is turned on, the cooling fan of the machine rotates agilely or not;
- (4) Switches contact well or not;
- (5) Cables are cut off or not;

b. Examine Items Once for 3-6 Months

- (1) Electric connection

The bolts of the connection at the input and output sides of the welding machine are loose or not. There are contact problems due to the rusts and insulation problems or not.

- (2) Grounding wires

The cover of the machine is connected with ground safely or not.

c. Eliminate the dusts inside the welding machine

The dusts deposited on the cooling board of thyristors will cause bad heat dispersal and bring adverse influence. The dusts deposited at the windings of the transformer will cause insulation deterioration. So, the examination should be carried out every half year, demounting the side board and top cover, using the dry compression air to clean the related parts.

d. High frequency adjustment

Generally, don't touch the spark electrode (the spark gap is 1 mm normally). When the surface of electrode isn't flat and has notable feculences, it should be burnished, and adjust the electrode gap to 1 mm.

e. Examination Points for Abnormal Action

e1. No arc initiation, No high frequency

- (1) The fuse of control circuit melts;
- (2) The high frequency fuse melts;
- (3) The spark gap is too large or is shorted;
- (4) The cable of torch's switch breaks off;
- (5) Turn the conversion switch of welding methods to "Stick welding";

E2. High frequency is ok, but no arc initiation

- (1) Forget to connect the cable to the mother-material or it is not connected perfectly.
- (2) The cables of the welding torch and mother-material breaks off;

INTIG 316/501 AC/DC

- (3) The gap of the tungsten electrode to the mother-material is too great;
- (4) The voltage of power source is too low (415±10% is better);

E3. Unsteady arc, Initiate arc difficultly, arc quenches

- (1) The tungsten electrode is too thick (relative to current value)
- (2) Pure tungsten electrode is used (should use the dthorium or cerium tungsten electrode)
- (3) The other shielded gases are used except pure argon;
- (4) The mother-material cable is not connected perfectly;
- (5) The gas flux is too large;

E4. Gas sending is bad or even not

- (1) Midway of the gas pipe is flexed
- (2) The torch is blocked by dunghills;
- (3) The gas valve doesn't act;

E5. Gas flows out of control.

- (1) The gas pipe leaks at the connection;
- (2) Fault of gas valve;

9. Trouble shooting

TROUBLE (SYMPTOMS)	POSSIBLE CAUSE	RECOMMENDED COURSE OF ACTION
1. When machine energized, the circuit breaker trip	Three phase bridge rectifier was may damage	Replace the rectifier ;
	IGBT damage	Replace IGBT
2. No output current	The control fuse on the back may broken	Replace fuse 1.5A
	Cooling fan not work, or overload cause overheat, then temperature relay protect	Repair the cooling fan and do not overload
	Temperature relay may damage	Replace the temperature relay
3. Arc strike can't success	Machine output terminal not connect reliably with the work piece	Reliably connect the work piece and output terminal
	Torch trigger or plug wire may damage	Replace the torch trigger and well connect the plug
4. There is no output voltage, but noise from the machine	FRD may damage	Replace the FRD
5. Difficult to strike arc	Workpiece too dirty	Clean the workpiece
	Tungsten quality not good	Replace good tungsten
6. Cannot turn off the argon gas.	PW03 damage ;	Replace PW03 ;
	There are substance in gas valve ;	Clean the air valve
	Check gas/auto selection switch does not set to auto position ;	Put the switch to auto position ;
	The spring in the air valve may have elastic shortage	open the air valve and extend the spring
7. No argon	The voltage of the air valve coil is insufficient or the coil was burnt	Check the coil voltage(~36V) or replace the air valve
	PW03 damage ;	Replace PW03 ;
8. There is burnt smell from the machine	Some components was burnet or there are wires short circuit.	Replace the damaged components or deal with the short circuit parts ;
9. Machine not work, but the overload indicator on	Machine overload	Stop welding, let the machine rest for 10min without load
	Cooling fan damage	Replace cooling fan
10. Arc break during welding or the machine not work, but the lack voltage indicator on	Water pressure too low or no water let in	Connect water
	The water checking switch damage	Replace the water checking switch
11. When use water cooling torch, machine not work, but the cooling water indicator on	The input lack-phase or lack voltage	Check three phase input

★★Note: if meet some problem can't solve, please turn off the machine immediately, only the professional worker can repair the machine.

INTIG 316/501 AC/DC

9.Packing list and appendix

■ power source (INTIG 316/501 AC/DC)	1 set
■ Instruction manual	1
■ Qualified certificate	1
■ Guarantee card	1

Important elements

No.	Item	Model		Technical	Series No.
1	Breaker	INTIG 316 AC/DC	DZ47D-3P/40A	40A	102010200002
		INTIG 501 AC/DC	DZ47D-3P/63A	63A	102010200003
2	Bridge rectifier	INTIG 316 AC/DC	MDS75-12	75A/1200V	102070100035
		INTIG 501 AC/DC	MDS100-12	100A/1200V	102070100045
3	IGBT	INTIG 316 AC/DC	FF50R12RT4	40A/1200V	102070100100
		INTIG 501 AC/DC	FF100R12RT4	100A/1200V	102070100030
4	IGBT	INTIG 316 AC/DC	FF400R06KE3	40A/1200V	102070100073
		INTIG 501 AC/DC	FZ600R12KE3	600A/1200V	102070100105
5	Filter capacity	INTIG 316 AC/DC	1000 μ F-400V/85	/	102020100041
		INTIG 501 AC/DC	2200 μ F-400V/85	/	102020100058
6	Main transformer	INTIG 316 AC/DC	/	/	2090311
		INTIG 501 AC/DC	/	/	2090411
7	Reactor	INTIG 316 AC/DC	/	/	2090312
		INTIG 501 AC/DC	/	/	2090411
8	Diode	INTIG 316 /501 AC/DC	MMF300N060DK6B	300A / 600V	102070100110
9	Diode	INTIG 316 /501 AC/DC	MMF300N060DA6B	300A / 600V	102070100111
10	Hall sensor	INTIG 316 /501 AC/DC	TKC500BR	500A	102060400001
11	Cooling fan	INTIG 316 /501 AC/DC	200FZY2-D/220V		103020000007
12	Control transformer	/	TW02		105010000639
13	PCB		PW03		111010000227
14	PCB	INTIG 501 AC/DC	PW04		111010000227
15	PCB	INTIG 316 AC/DC	PW05		111010000252
16	PCB		PW06		111010000253
17	PCB		PW07		111010000255
18	PCB		PT01		111010000204
19	PCB		HFAP1		111010000201

INTIG 316/501 AC/DC

Appendix :

INTIG 316 AC/DC electric schematic

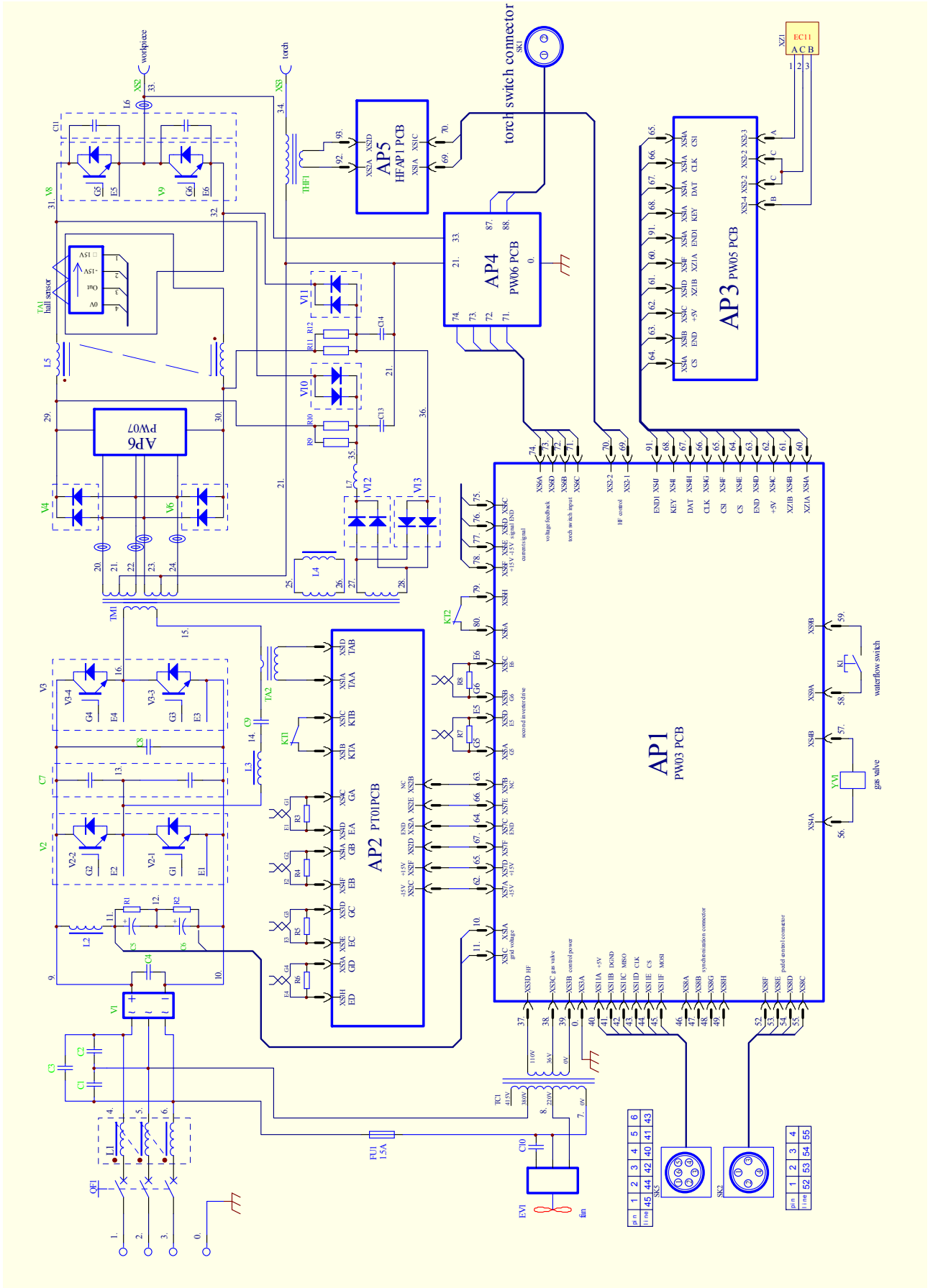

INTIG 316/501 AC/DC

INTIG 501 AC/DC electric schematic

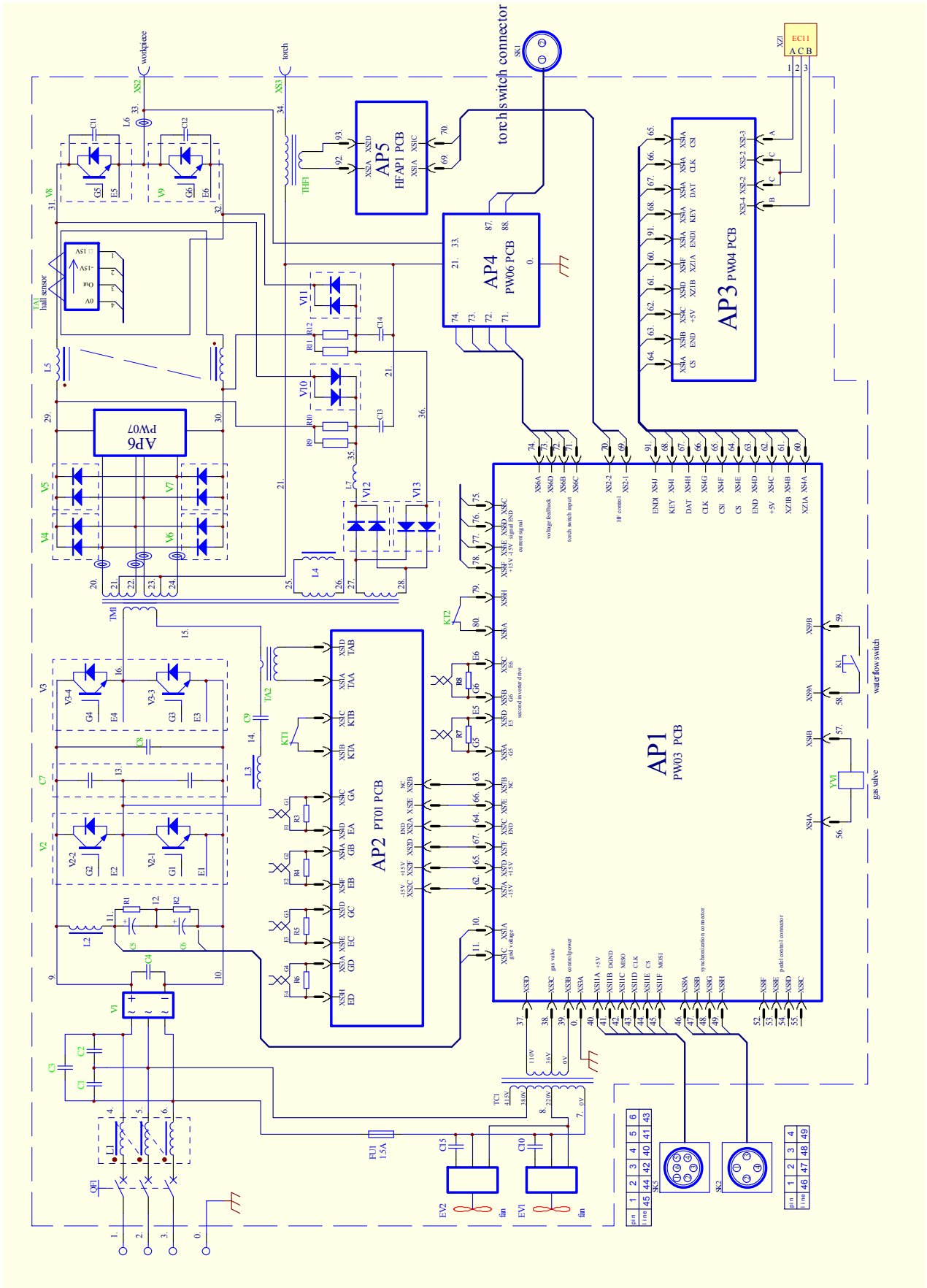

1.Top View.

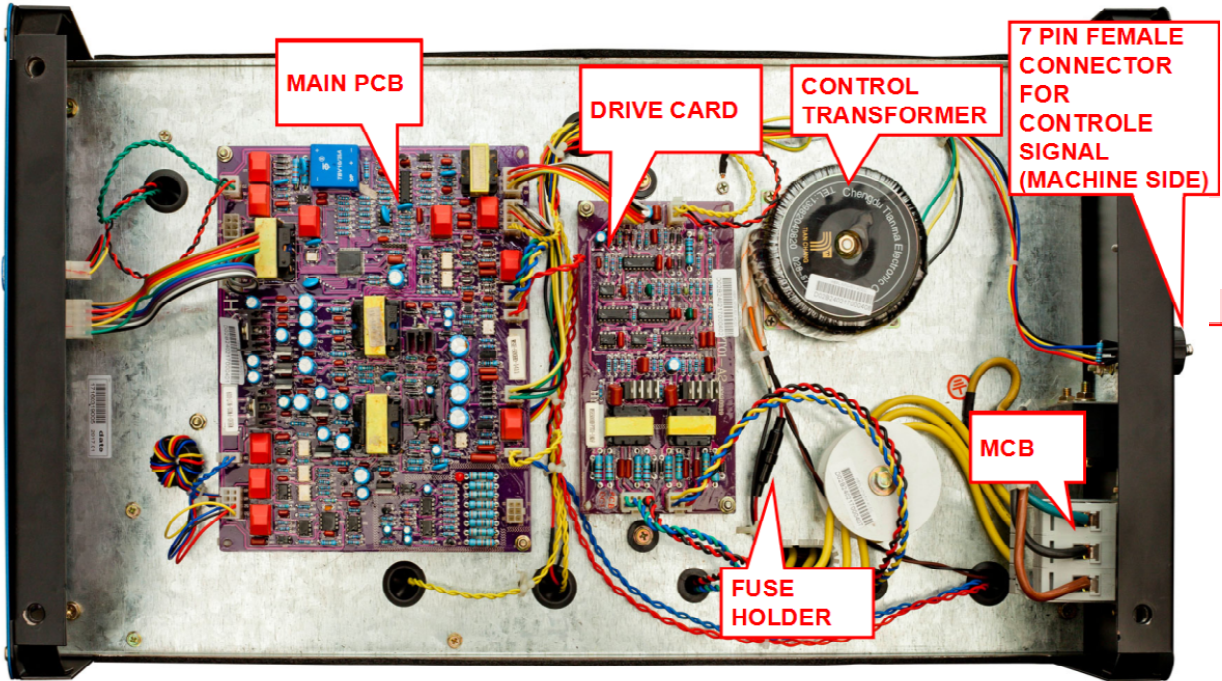

2.Right side View

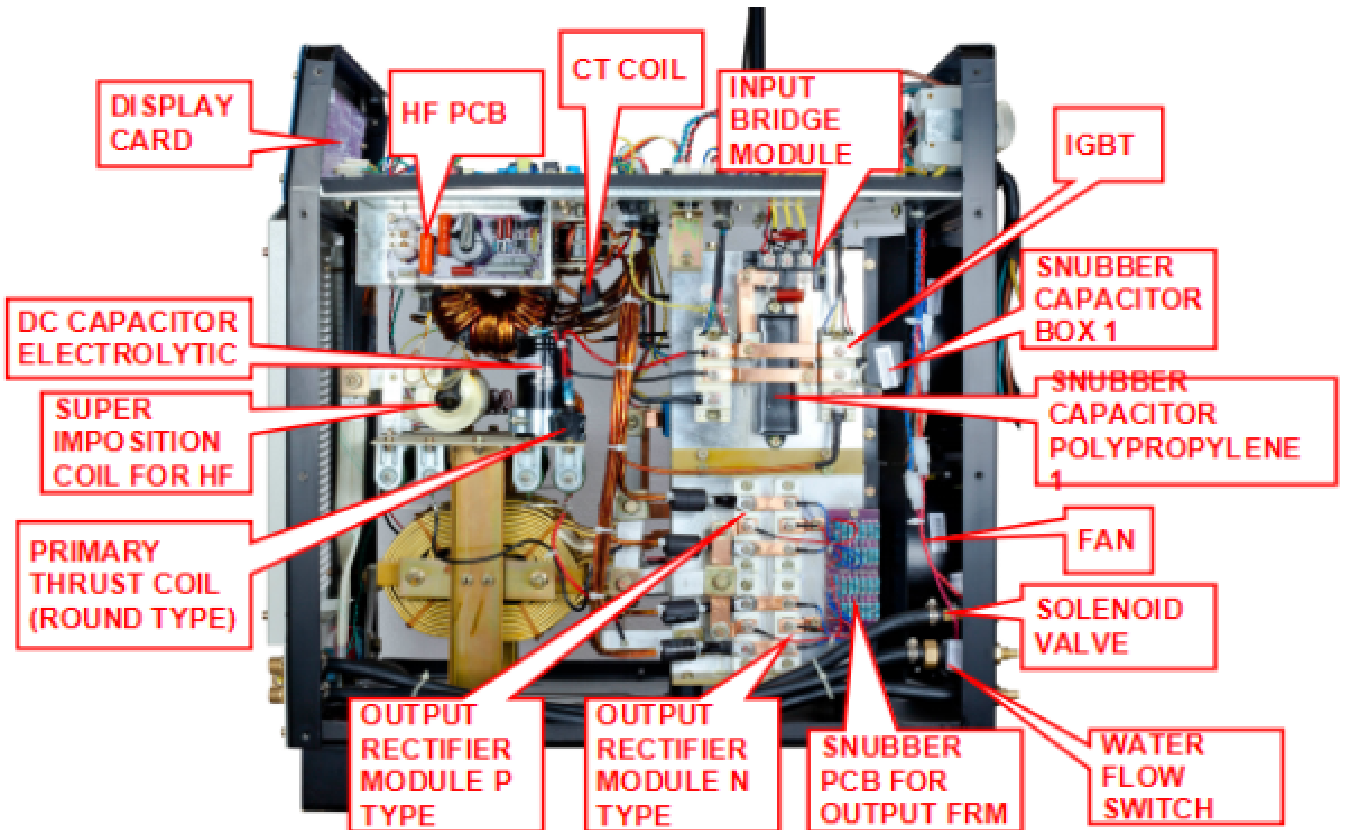

3. Left side View

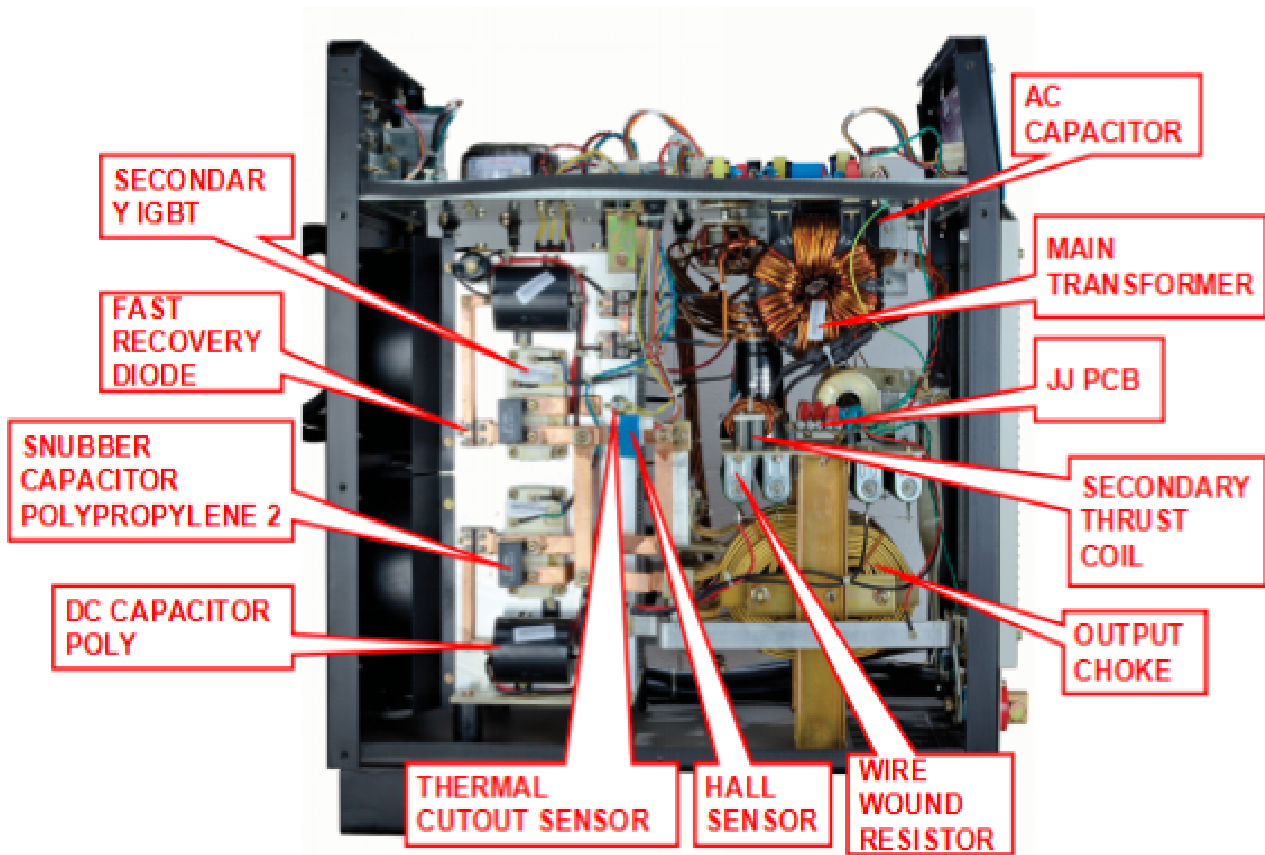

4. Front View

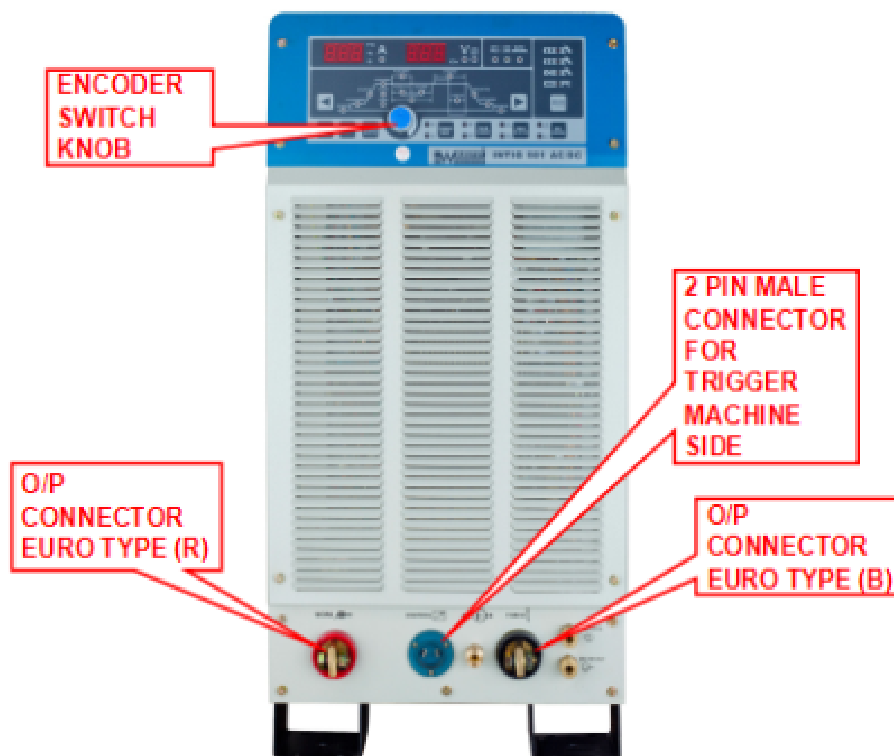

INTIG 316/501 AC/DC

Spare parts List for INTIG 316, 501 AC/DC.			
		INTIG 316 AC/DC	INTIG 501 AC/DC
S.No	Description.	Part Code	Part Code
1	2 PIN FEMALE CONNECTOR FOR TRIGGER CABLE SIDE	CON-2-CM-F01	CON-2-CM-F01
2	2 PIN MALE CONNECTOR FOR TRIGGER MACHINE SIDE	CON2PNM	CON2PNM
3	7 PIN FEMALE CONNECTOR FOR CONTROL SIGNAL (MACHINE SIDE).	CON7PNF	CON7PNF
4	7 PIN MALE CONNECTOR FOR CONTROL SIGNAL (CABLE SIDE).	CON7PNM	CON7PNM
5	AC CAPACITOR	C-4UF/1000VAC	C-5UF/1000VAC
6	CONTROL TRANSFORMER	CTRXB24	CTRXB24
7	CT COIL.	CTCOIL-316	CTCOIL-501
8	DC CAPACITOR ELECTROLYTIC	C-1000UF/400VDC	C-2200UF/400V
9	DC CAPACITOR POLY	C-100UF/500VAC	C-100UF/500VAC
10	DISPLAY CARD	PCB-DSP-04	PCB-DSP-04
11	DRIVE CARD	PCB-DRV-05	PCB-DRV-05
12	ENCODER SWITCH KNOB.	KNOB001	KNOB001
13	FAN	FAN0012	FAN005-AC240V
14	FAN CAPACITOR.	CAP05	CAP05
15	FAST RECOVERY DIODE.	FRM-MPSC2N100U60	FRM-MPSC2N100U60
16	FUSE HOLDER	FUSE-HOLDER-02	FUSE-HOLDER-02

INTIG 316/501 AC/DC

17	HALL SENSOR	CS-4.0V-500A	CS-4.0V-500A
18	HF PCB	PCB-HF-02	PCB-HF-02
19	IGBT	IGBT5012	IGBT-10012
20	INPUT BRIDGE MODULE	IBDG007	IBDG003
21	JJ PCB	PCB-ISO-05	PCB-ISO-05
22	MAIN PCB	PCB-TIG-AC/DC316	PCB-TIG-AC/DC501
23	MAIN TRANSFORMER	MTRXB25	MTRXB24
24	MCB	MCB001	MCB001
25	O/P CONNECTOR EURO TYPE (B)	OCN-EURO-S 50 (B)	OCN-EURO-S 50 (B)
26	O/P CONNECTOR EURO TYPE (R)	OCN-EURO-S 50 (R)	OCN-EURO-S 50 (R)
27	OUT PUT CHOKE	CHK005	CHK006
28	OUTPUT RECTIFIER MODULE P TYPE	FRM-MPKC2CB150U60	FRM-MPKC2CB150U60
29	OUTPUT RECTIFIER MODULE N TYPE	FRM-MPKC2CA150U60	FRM-MPKC2CA150U60
30	PRIMARY THRUST COIL (ROUND TYPE)	THCL-P-316	THCL-P-501
31	ROTATION ENCODER	C2373	C2373
32	SECONDARY IGBT	IGBT-FF400R06KE3	IGBT-FZ600R12KE3
33	SECONDARY THRUST COIL.	THCL-S-316	THCL-S-501
34	SNUBBER CAPACITOR BOX 1	C-0.027UF/1000V	C-47UF/1200V
35	SNUBBER CAPACITOR BOX 2		NA
36	SNUBBER CAPACITOR POLYPROPYLENE 1	C-8UF/800VDC	C-0.027UF/1000V
37	SNUBBER CAPACITOR POLYPROPYLENE 2	NA	C-0.47UF/1200V
38	SNUBBER PCB FOR OUTPUT FRM	PCB-SNB-OUT-06	PCB-SNB-OUT-06
39	SOLENOID VALVE	SV001	SV001
40	SUPER IMPOSITION COIL FOR HF	SUP-IMPOS-HF	SUP-IMPOS-HF

INTIG 316/501 AC/DC

41	THERMAL CUTOUT SENSOR	C2373	C2373
42	WATER FLOW SWITCH	FS-DS01AW131DH	FS-DS01AW131DH
43	WIRE WOUND RESISTOR	R-20E-200W	R-20E-200W