



AIRCUT -300IW

INVERTER AIR PLASMA CUTTING MACHINE

OPERATOR'S MANUAL

(PLEASE READ IT CAREFULLY BEFORE OPERATION)

M/s WARPP ENGINEERS PVT. LTD.

36/15, Unique Industrial Estate Dhumal Nagar, VASAI (E),

Distt. Palghar PIN 401208 Maharashtra (INDIA)

Contact No.8551817744, 8551819944

Email id : salesupport@warpp.co.in

Website : www.warpp.co.in

Safety Depends on You

WARPP arc welding and cutting equipments are designed and built with ample safety consideration.

However, proper installing and operating can ensure your safety.

DO NOT INSTALL, OPERATE OR REPAIR THIS EQUIPMENT CASUALLY WITHOUT READING THIS MANUAL THROUGHOUT.

Special Notes (Very Important):

1. Pay attention to avoiding the machine falling down when it is placed on the gradient ground.
2. It is forbidden to unfreeze the pipeline by the cutter.
3. The shield rank of this series of cutter is IP21, so working in rain is not suitable.
4. The cutter has external static characteristic with rated duty cycle 100%, which means the machine can work continuously at the rated cutting current. The machine has the function of thermal protection. When the internal temperature exceeds a set temperature, thermal protection moves on and the abnormality indicator lamp on the panel turns ON, then there is no output of cutter. The machine can become normal and work only after the internal temperature drops down and the abnormality indicator lamp on the panel turns OFF.

Purchase Date: _____

Serial Number: _____

Machine Model: _____ AIRCUT 300 IW _____

Purchase Place: _____



Cautions

Arc and arc rays can hurt.

All performing welding workers ought to have health qualification from the authority organization to prevent you and others from arc radiation and burn. It should be prevented for children to enter into dangerous area as well.

Be careful reading the following important items and the welder safety byelaw from the authority organization. Be sure that qualified professionals perform all installation, maintenances and repair procedures.



1 Electric shock: The welding circuits are not insulated when welding/cutting. If you touch the two output electrodes of the machine with your bare skin at the same time, it will lead to electric shock, sometimes even fatal dangers. Users need to follow the

items below to avoid electric shocks:

- If possible, lay some insulating materials, which are dry and large enough, in your working field. Otherwise, use the automatic or semiautomatic welding machine, DC welding machine as possible as you can.
- Components in the automatic and semiautomatic welding machine such as the welding wire reel, feed wheel, contact tip and welding / cutting head are all electric components. .
- Always be sure the machine has been connected perfectly to the work piece with the work cables and should be as close as possible to the working area.
- The work piece should be grounded perfectly.
- Make sure that the insulating material of the electrode holder, the grounding clamp, the welding cable and the welding head are not affected by damp, mildewed or spoilt, and be replaced momentarily.
- Never dip the electrode in water for cooling.
- Never touch electric components of two welding / cutting machines at the same time, because this voltage is supposed to be two times of welding voltage while the grounding mode is not clear.
- While working high above the ground or other places having the risk of falling, please be sure to wear safety belt to avoid losing balance caused by electric shock.







2 Arc: Use an arc welding mask to protect your eyes and skin from sparks and the rays of the arc, pay special attention to the filter glass, which must be conformable to the national standard.

- Use clothing made from durable flame-resistant material or sailcloth to protect your skin from hurting by the arc rays.
- Remind other nearby personnel before working lest arc rays hurt them by accident.



3. Fumes and Gases: Welding / cutting may produce fumes and gases hazardous to health. Avoid breathing these fumes and gases. While working in limited room, use enough ventilation and/or exhaust to keep fumes and gases away from the breathing zone, or use the respirator. Do not weld at the same time when using of degreasing, cleaning or spraying operations. The heat and rays of the arc can react with these gases to form phosgene, a highly toxic gas,

- Some protective gases used in welding might displace the oxygen in the air, and can lead to hurt or even death.

<ul style="list-style-type: none"> ■ Read and understand the manufacturer's instructions for this equipment, and validate the health certification of consumptive materials, make sure they are innocuous. 	
	<p>4. Spatter: Spatter can cause fire or explosion.</p> <ul style="list-style-type: none"> ■ Remove fire hazards from the welding area. Remember that spatter from welding can easily go through small cracks and touch fire hazards. Protect all kinds of lines going through welding area, including hydraulic lines in the wild. ■ Where compressed gases are to be used in the field, special precautions should be used to prevent explosion. ■ When welding stops, make certain that no live part is touching the work piece or the work stage. Accidental contact can create a fire hazard. ■ Do not weld containers or lines, which are not proved to be innocuous. ■ It is very dangerous to heat, cut or weld tanks or containers at entry holes. Does not start work until the proper steps have been taken to insure that there is no flammable or toxic gas. ■ Spatter might cause burn. Wear leather gloves, heavy shirt, cuffless trousers, high shoes and a cap over your hair to prevent from burning by spatter. Wear the ear shield when performing sideways or face up welding. Always wear safety glasses with side shields when being in a welding area. ■ The welding cables should be as close to the welding area as possible, and the short, the better. Avoid welding cables going through the building framework, lifting chains, AC or DC cables of other welding machines and appliances. The welding current is strong enough to damage them while having short circuit with them.
	<p>5. Power: (For electrically powered welding and cutting equipment) Turn off input power before installation, maintenances and repair, so that avoid accident.</p> <ul style="list-style-type: none"> ■ WARPP welding & cutting equipment is class I safeguard equipment; please install the equipment in accordance with the manufacturer's recommendations by specific persons. ■ Ground the equipment perfectly in accordance with the manufacturer's recommendations.
	<p>6. Power : (For engine driven welding and cutting equipment)</p> <ul style="list-style-type: none"> ■ Work in ventilated place or outdoors.
	<ul style="list-style-type: none"> ■ Do not add fuel near to fire or during engine starting or welding & Cutting . When not working, add fuel after engine is cooling down; otherwise, the evaporation of hot fuel would result in dangers. Do not splash fuel out of the fuel tank, and do not start the engine until complete evaporation of the outside fuel.
	<ul style="list-style-type: none"> ■ Make sure that all the safeguard equipments, machine cover and devices are all in a good condition. Be sure that arms, clothes and all the tools do not touch all the moving and rotating components including V belt, gear and fan etc. ■ Sometimes having to dismantle some parts of the device during maintenance, but must keep safety awareness strongly every time. ■ Do not put your hand close to fans and do not move the brake handle while operating. ■ Please remove the connection between the engine and the welding / cutting equipment to avoid sudden starting during maintenances.
	<ul style="list-style-type: none"> ■ When engine is hot, it is forbidden to open the airtight cover of the radiator water tank to avoid hurt by the hot vapor.



7. Electromagnetic: Welding current going through any area can generate electromagnetic, as well as the welding equipment itself.

- Electromagnetic would affect cardiac pace maker, the cardiac pacemaker users should consult one's doctor first.
- The effect of electromagnetic to one's health is not confirmed, so it might have some negative effect to one's health.
- Welders may use following method to reduce the hazardous of electromagnetic:
 - a. Bundle the cable connected to the work piece and the welding cable together.
 - b. Do not enwind partially or entirely your body with the cable.
 - c. Do not place yourself between the welding cable and the ground (work piece) cable, if the welding cable is by your left side, then the ground cable should be by your left side too.
 - d. The Welding cable and the ground cable are as short as possible.
 - e. Do not work near to the welding power source.



8. Lift Equipment: carton or wooden boxes package the welding / cutting machines supplied by WARPP. There is no lifting equipment in its wrapper. Users can move it to the prospective area by a fork-lift truck, and then open the box.



- If having rings, the machine can be transited using rings. While WARPP Welding / Cutting Machine Manufacture reminds users, there is possible risk to damage the welding machine. It is better to push the welding machine moving in use of its rollers unless special situations.

- Be sure that the appurtenances are all removed off when lifting.
- When lifting, make sure that there is no person below the welding machine, and remind people passing by at any moment.
- Do not move the hoist too fast.



10 Noise: WARPP Welding Machine Manufacture reminds users: Noise beyond the limit (over 80 db) can cause injury to vision, heart and audition depending on oneself. Please consult local medical institution. Use the equipment with doctor's

permission would help to keeping healthy.

CONTENTS

- ◆ Summary
- ◆ Safety and Attention
- ◆ Work Environment Conditions
- ◆ Technical Specification
- ◆ Working Principles
- ◆ Panel and Functions
- ◆ Protection function of the cutter
- ◆ Installation and Operation
- ◆ Machine use cutting machine installation and connection.....
- ◆ Maintenance
- ◆ Cutting technology instruction
- ◆ Troubleshooting and Repair
- ◆ Circuit Diagram

◆ Summary

1. Model description
2. Characteristics

AIRCUT 300IW inverter air plasma cutting machine is a new generation cutter of our company. It has good characteristics as following :

- 1) This cutting machine adopts IGBT inverter technology which has high reliability and efficiency. It is light weight.
- 2) Pre-set current function. Stepless adjustable cutting current, suitable for cutting various thickness work piece. To ensure cutting quality and save energy, low current is applied to cut thin plate, and high current is applied to cut thick plate.
- 3) External and dynamic characteristics cutter are significantly better than leakage-reactance typed cutter. High success rate in striking arc. Stable cutting current. Good arc stiffness. Clean and smooth incision. Excellent technology performance.
- 4) It has the function of ascending current slowly, which can effectively extend the work life of consumables part and cutting torch.
- 5) Quite suitable for CNC automatic cutting and has all signal output which is required by CNC control.
- 6) The cutting current is very stable and it will not be influenced by supply voltage fluctuation.
- 7) 100% duty cycle. It can work continuously under max current.
- 8) Have over/ under voltage and phase missing protection function.

3. Usage

It is suitable for cutting kinds of metal materials like low carbon steel, alloy steel and non-ferrous metal and is widely applied in the manufacturing of boiler pressure container, chemical container, industrial power station construction, metallurgy, aerospace industry, automobiles, building an so on.

◆ Safety and Attention :



Please follow the notes for the safety of you and others.

- ※ It is forbidden to unfreeze the pipe line by cutting power or other usages except for cutting.

The cutter casing should ground reliably. Please make sure the grounding bolts of power ground reliably in case of electric shock.

Cutter is the equipment with high voltage. Please wear insulated protective shield when cutting.

- ※ When exchanging torch and wearing parts, please turn off the supply power first.
- ※ Protective shield should be worn.

In order to avoid any hurt to eyes from ultraviolet radiation and strong light and to skin from spatter, please wear protective shield according to related rules and regulations of labour protection.

- ※ It is forbidden to inhale harmful gases.

The fumes and gases produced during cutting is hazardous to health. Please wear protective shields and install aerator according to related rules and regulations of labor

protection.

- ※ Cutting cannot proceed in closed container.
- ※ The work piece just after being cut is at high temperature. Please prevent from scald.
- ※ Protective gas cylinder and air compressor must be placed in a fixed position and prevented from collision.
- ※ Cutter and cutting place should be far away from flammable materials.
- ※ Prevent foreign bodies from entering inside the machine. And protect the cable from sharp materials.
 - ※ Protect the machine from fall or collision.
In case of fall or collision, it can be used only after professional checking.
 - ※ In the surface or inside of the cutting workpiece, there should be no flammable and explosive materials or chemical materials harmful to human.
 - ※ Installation and repair person must have state-authorized electrician operation certificate.
 - ※ Cutting operation person should read this manual carefully and know the operation method well.

◆ **Work Environment Requirements :**

Cutting performance may not meet technical standards without the following condition :

1. It should be placed with without dust, no corrosive gases and no flammable and explosive materials. Avoid vertical sunshine and rain;
2. Air relative humidity is no more than 90% at 20 degree C and no more than 50% at 40 degree C.
3. When using air cooling torch, the ambient temperature should be from -10 degree C to 40 degree C.
4. It should avoid metal foreign bodies entering into the cutting power.
5. Cutting power should be 30cm away from the wall or other sealed-in objects. The distance between two sets should be above 30cm.
6. The operation height should be less than 1000m.

◆ Technical Specification :

1. Main Technical parameters

Model	AIRCUT 300 IW
Rated input voltage	3~380V – 440 V/50Hz
Rated input capability	65 KVA
Rated output current	300A
Rated output voltage	130 - 140V
Rated duty cycle	100%
Open circuit voltage	380VDC
Current adjusting range	60~300A
Insulation Class	H
Max cutting thickness (steel)	80mm
Applied plasma air	Compressed Air
Work plasma gas pressure range	0.45~0.6 MPa
Torch cooling model	water cooling
Arc striking method	Non-contact
Dimension(L×W×H)	890×430× 900
Weight	140Kg

2. Plasma gas conditions

- Air pressure range: 0.4MPa~0.6MPa
- Gas supply pipe compression strength : $\geq 1\text{MPa}$
- Gas supply pipe inner dimension: $\geq \Phi 8$
- Gas supply flux: $\geq 180\text{L/min}$
- Drain water from compressor and then put it into cutter

◆ Working principles :

The control circuit of cutting machine adopts advanced electronic part IGBT as the main inverter switch component. Three-phase AC power is converted to 20 KHz high-frequency DC voltage after being rectified by three phase rectifier. Then under the function of IGBT inverter the DC current is inverted to AC high frequency voltage, which is inverted to DC voltage after experiencing voltage reduction in high frequency transformer, voltage rectifying in fast recovery diode. This DC voltage is filtered through reactor, and the output cutting voltage is obtained. Control circuit can control output current by controlling driven pulse width. The real time cutting current, which is obtained through current sensor connected to output terminal in series, is used as negative feedback control signal. After comparing with current adjusting signal, the negative control signal is sent to PWM adjusting integrated circuit, then a controlled driving pulse is output to control IGBT. Thereby a constant output current can be maintained, and a steep dropping & constant current external characteristic is obtained. Striking arc adopts high-frequency striking model. The main circuit refers to appendix figure1, and principle diagram of control circuit is shown as figure 2.

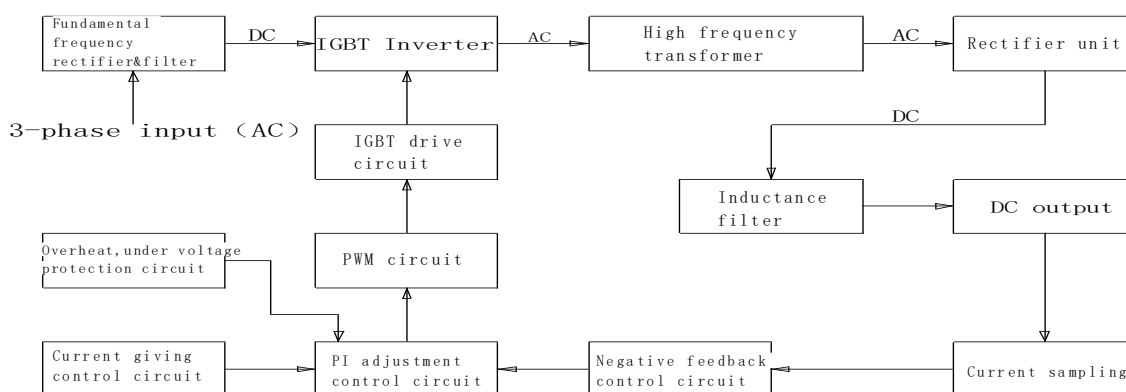

Figure 1 Principle diagram

◆ Panel and its functions :

1. Digital ammeter: Displaying pre-set cutting current before cutting, displaying cutting current when cutting
2. Cutting current adjusting knob: Adjusting cutting current
3. Power indicator lamp: Indicating if the cutter is energized.
4. Air pressure indicator lamp: It is ON when the pressure of compressed air exceeds 0.2Mpa. It is OFF when the pressure is less than 0.15Mpa.
5. Water pressure indicator: connect with the cooling water, when flow meter more than 0.45L/min, the indicator on
6. Cutting indicator lamp: When the lamp ON means the cutting machine has started.
7. Overload indicator lamp: It is ON when the cutter is over loaded (generally it is on when cooling fan is damaged.)
8. Input fault indicator lamp: It is ON when power source misses phase or it is less than 330VAC.
9. Torch operate selection switch: when put it on 2 step mode, the torch switch must be pressed during welding, and welding stop when release the switch. When put it on 4 step mode, press down the torch switch, the welding begin, then press again, the welding stop.
10. Torch operation mode selection switch: When it turns on 2-Step, the torch switch should be pressed at the process of cutting, and the cutting comes to stop after loosening the switch. When it turns on 4-Step, press the torch switch and loosen it, the cutting starts to work, and comes to stop after pressing the switch again.
11. Gas control selection switch: When it switches to check air, gas valve opens to test gas flux. When it switches to Cutting, the gas valve opens during cutting automatically.
12. Power switch: control the machine three phase input
13. Cutting ground wire outlet: To connect cutting ground wire
14. Torch Pilot terminal: To connect torch pilot wire.
15. Torch control outlet: To connect torch control signal wire.
16. Air & Power output terminal: the current output terminal is also the compressed air output terminal. It is gas pipe connector to connect water-cooled torch when the water-cooled

torch is used, and it is connector to connect torch gas-cooled cable when air-cooled torch is used.

17. Water output connector: output current connector is also the water output connector, which is used to connect the torch water cooling cable connector.
18. Backwater terminal: it is used to connect the water tank recycle pipe.
19. Spare wire hole for arc voltage output: the arc voltage output wire is not connected when the machine is finished. If it is needed, please open the cutter top cover, and use two-core wire to connect the wire terminal on printed board LGK7-AP7, which has two kinds of output signal, one is the 1:1 output and the other is 1:20 output, please
20. Control signal connector: To control automatic cutting equipment
21. Air pressure regulation filter: For adjusting work pressure of compressed air and filtrating water from air.
22. Water/Power output terminal: the cutting current output terminal is also the water output terminal, it is used to connect the water cooling cable.
23. Backwater terminal of the torch: It is used to connect the water recycle pipe.
24. Water input terminal: it is used to connect the water tank output pipe.
25. Earth connecting screw: connect with the earth

◆ **Protection function of the cutter :**

➤ **Air pressure protection**

1. When the indicated value of the pressure meter, which is fixed on the back of the cutter, is lower than 0.2 MPa, the protection circuit starts working and the cutter cannot start.
2. When the indicated value is lower than 0.15 MPa during cutting, the cutting arc will extinguish.

Note: When adjust the air pressure, the panel function must be set to 'air checking'.

➤ **Water pressure protection**

1. When the water supply is lower than 0.45L/min, protection circuit starts working and cutter cannot start.

When the water supply is lower than 0.4L/min during the process, protection circuit starts working and cutting arc extinguishes automatically.

➤ **Over-heat protection**

When the ambient temperature is too high or the cooling fan is broken, the cutter will be over heated under the rated current, and heat protection circuit starts working, the cutting arc will extinguish automatically.

➤ **Abnormal power supply protection**

1. When 3 phases power supply misses phase, protection circuit starts working and there is no arc striking.
2. When 3 phrased power supply is lower than 330VAC, protection circuit starts working and there is no arc striking.

Note: the water and air pressure protection function is for protecting the torch only.

◆ Installation and Operation

1. Transport and Lift

- A. Power source should be shut off before moving the cutter.
- B. The cutter bottom should be kept downwards during transportation. It is forbidden to have cutter placed transversely or upended.
- C. When lifting, it must be lifted vertically.
- D. During the long-distance transportation, it must prevent the cutter from raining and moving back and forth inside box. Shock absorption foam should be placed around cutter.

2. Installation and Connection

- A. Power source should be shut off before installation and connection.
- B. Installation environment details refers to the point “Work Environment Requirements”.
- C. If cutting power source is placed in a slanted surface, it must be prevented from falling down.
- D. Shield rank for cutting power is IP21S. The installation and operation cannot be proceeded in the rain.

3. Power supply requirements

- A. Voltage fluctuation $\leq \pm 10\%$;
- B. Frequency fluctuation $\leq \pm 1\%$;
- C. Asymmetry rate of three-phase supply system $\leq 5\%$;
- D. Power supply wire cross profile, ground wire cross profile, breaker and fuse should refer to the diagram below.

Items	LGK-300IGBT
Power supply wire cross profile (mm ²)	≥ 35
Ground wire cross profile (mm ²)	≥ 35
Breaker capacity (A)	160A
Fuse capacity (A)	150

4. Installation of supply wire

Shut off the power switch first. Connect the power input wire of cutter back panel to distribution box which meets the parameters in the diagram above.

5. Connection of ground wire

Connect the green-yellow wire of power source line, which cross profile must match the requirements in above form, to ground firmly. Earth connecting method should follow state standard.

6. Connection of compressed gas.

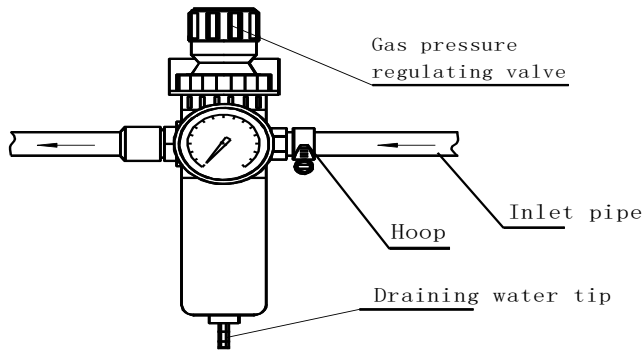

The compressed gas should meet the requirement mentioned in point “Plasma gas conditions”. Connect the gas pipe with the gas inlet of air filter on the back panel and hoop it tightly.

The usage of air filter regulator is as follows. When it is to adjust pressure, lift up air pressure regulating valve, and rotate it. Left rotation aims to reduce outlet gas pressure, right rotation aims to increase outlet gas pressure. After the gas pressure is adjusted properly, press down regulating valve.

The air filter regulator should be checked periodically. If the water level reaches two-thirds of filter glass, it must be drained, or this will affect incision quality. The gas supply valve should be closed during water draining, and Gas Checking function is selected in panel. When the indicated valve of gas pressure meter is zero, water will drain out from drainage mouth automatically.

7. Connection of cooling water

Connect the copper nozzle marked with “water inlet” on the cutter back side with water supply pipe, and tighten it. Connect the copper nozzle marked with “Backwater” with water recycle pipe, and tighten it.

Notes: when apply gas cooling torch, the torch selection switch on panel must be set to air-cooled torch position, and the cooling water cannot be connected with. The cooling water is for cooling torch only, and cutter power source does not need water cooling.

8. Connection of cutting torch

✧ Torch connection

The torch model matched to plasma power source is as below:

Power source model	AIRCUT 300 IW
Torch model	PLTCH-300 H-KIT Water cooling

✧ The selection of torch nozzle

The best current range for different nozzles is different. Please select the nozzle according to below form.

Nozzle aperture dia. (mm)	1.6	1.8	2.0	2.2	2.4	2.6	3.0
Suitable current (A)	70~ 90	80~ 100	110~ 130	140~ 170	180~ 210	220~ 250	250~ 300

✧ Connection of air-cooled torch: first connect the torch cable connector M14 nut with the

copper nozzle signed with Air & Power on the front panel, and screw down the nut; then connect the torch pilot wire to terminal signed with Pilot on the front panel and screw down the nut. Finally, connect the torch control pin to the terminal signed with Control Signal on the front panel and screw down the nut.











Special notes: it should not exceed the rated current of torch when use air cooling torch, or it will be damaged by heat.

- ◇ Connection of water-cooled torch: first connect the torch cable connector M16 nut with the copper nozzle marked with Water& Power output on the front panel, and screw down the nut. Connect the backwater pipe M10 nut of torch with the copper nozzle marked with Backwater on the front panel, and screw down the nut. Connect the torch gas pipe M14 nut with the copper nozzle marked with Air& Power output and screw down the nut. Then connect the pilot wire with the terminal marked with Pilot on the front panel, and screw down the nut. Finally, connect the control plug of torch with the socket marked with Control Signal, and screw down the plug nut.

Operation method

a)Security Notes

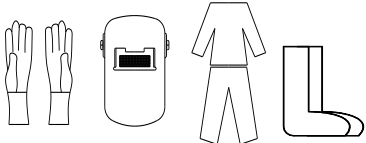
 Notes :	Operation strictly accordant with the following steps		
	 Notice Electric shock may hurt or even kill man. <ul style="list-style-type: none"> •Shut off the power during connection •Do not touch the conducted parts 		Cutting may cause fire or explosion <ul style="list-style-type: none"> •Splashes may ignite flammable materials nearby. Those materials should be 10m away from the working place.
	Fume & dust is harmful. <ul style="list-style-type: none"> •Do not breathe in the fume and dust caused by cutting •Clean up the oil spot on work piece. •Keep fresh air in working place •Fume extraction equipment should be prepared. 		Arc may hurt your eyes and skin. <ul style="list-style-type: none"> •Strong arc may hurt your eyes. •Ultraviolet radiation generated by arc may hurt skin and eyes. Please wear shielded guard when cutting.
	Overheated part may hurt your skin. <ul style="list-style-type: none"> •Do not touch the overheated part on the work piece. •Do not touch hot cable or torch just by hands. 		Fast moving thing may injure you. <ul style="list-style-type: none"> •Do not put your hands or other things into the fan shield. •Cover the opened case shell well during cutting operation.
		In case of injury for your skin and eyes, please wear required guards according to Labor Security and Hygiene rules. Electrode and nozzle should be replaced only after the cutter is power off.	
13			
Operation should proceed according to related Labor and Security regulations.			

- b) Turn on the power switch after installation and connection. Then the power indicator lamp is ON.
- c) Start gas supply equipment and turn on the gas supply switch, the power indicator lamp on the panel is ON. If the gas pressure is less than 0.25Mpa, the lamp will be OFF, then the gas source should be checked.
- d) Start water supply equipment. The indicator lamp of water pressure on panel is ON when opens water supply valve.
- e) Gas control switch switches to Check Air. Adjust the Adjusting knob of air filter regulator on the back panel to make the output pressure and flux fit cutting condition. After adjusting, have the switch pointed to Cutting position.
- f) Select panel operation method and control switch point. At 2-Step point, the torch switch should be pressed all the time during cutting. After loosening, the cutting comes to stop. At 4-Step point, press the torch switch and then loosen it, and cutting can start. User can make selection according to his operation habit.
- g) Checking the panel indicator lamps. The indicator lamps status, under which cutting can be operated, is shown as following diagram.

Indicator Lamp	Power	Cutting	Gas pressure	Water pressure	Overheated	Supply abnormality
Status	ON	OFF	ON	ON	OFF	OFF

- h) Keep the torch nozzle 2 to 5mm away from work piece. The axis line of nozzle should be perpendicular to work piece, and starts cutting from the edge of work piece. When the plate thickness is $\leq 12\text{mm}$, a hole can be drilled on work piece and then cutting can be started around the hole. The cutting torch should incline to one side a little during drilling a hole on work piece, so that the molten metal can be blown away easily. To drill a hole by use of plasma arc is not proposed, because this will damage nozzle easily, it is better to drill a hole in arc striking point first, then strikes arc on the edge of hole. Press down torch switch, compressed gas sprays out from nozzle, and cutting indicating lamp is ON. After gas pre-flows for 1 to 2 seconds, high frequency is generated, arc is struck, and cutting begins by moving torch.
- i) When the control switch of operation method on front panel is at 2-Step point, press down the torch switch and cutting starts after arc striking. After loosening the switch, there is no voltage output, and cutting ends, and compressed gas stops supply in 9 seconds. When it is at 4-Step point, press down the switch and loosen it, and cutting starts after arc striking automatically. Press the switch again or press it till the arc is off, then there is no voltage output, cutting ends, and compressed gas stops supply in 9 seconds.

◆ Maintenance

The cutter cannot be operated and placed in strong sunshine.

2. The cutter cannot be operated and placed in moist environment.
3. The vent hole should not be covered when the cutter is operated.
4. The cutter should be operated and placed in drafty environment.

5. The cutter casing should be opened once a year at least. Clean up the dust and metal scraps inside the machine by use of compressed gas.
6. Check regularly if the cable insulation cover is damaged. If there is any damage, repair it or change it.
7. Check regularly if the electric connection is loose and then tighten it.
8. Drain out regularly the water and impurities from filtering reducing valve.

Notes: When maintaining the cutter, professional electrician is required to dismantle the power wire from distribution box and open the machine casing.

◆ Cutting technology instruction

1. The related main technical parameters

● Cutting material and thickness

The selection of cutting technical parameters is based on the cutting material and thickness. If the material is thick, it should adopt large current and nozzle with big aperture. For different material under the same thickness, the parameter should also be different.

● Nozzle selection

The three main dimension of nozzle are the diameter of nozzle ϕ , the hole pass length ι and the compacted angle α , they all can affect the cutting. There should be a certain proportion between ι and ϕ , the value is usually lower than 2, and it usually takes $\frac{\iota}{\phi} = 1.5 \sim 1.8$, the compact angle usually takes $\alpha = 30^\circ \sim 60^\circ$, and now it usually takes $\alpha = 30^\circ$.

● Cutting current and arc voltage

The selection of cutting current should be according to the diameter of the nozzle, the relationship between the two should be as: $I(\text{current A}) = (70 \sim 100) \times \phi(\text{mm})$. As the increase of the metal thickness, the influence of arc current to the cutting speed will become less. But as the increase of current, the burning damage will be worse for the electrode and the nozzle. So when cutting a thick metal work piece, usually the increase of cutting speed is made by increasing arc voltage. The actual arc voltage is decided not only by the gas type but also by the air flux and nozzle shape. Working voltage increases with the increase of gas flux.

● Gas flow Q

The arc voltage increases as the increase of air flow, that is, the arc power, the cutting speed, as well as the cutting capacity and quality is improved accordingly. Because the arc compression level increases, the energy is more concentrated, the arc beam temperature, the arc spraying speed, as well as the arc current impulsion increases. But overlarge current may cause the instability of the plasma arc. Usually no change is made to air flow for one torch. But it can be adjusted a little when the cutting torch or cutting thickness is different.

● Electrode inner contraction ΔL_y

When electrode inner contraction ΔL_y is so small that electrode extends into spray hole, electrode is damaged seriously by air flow impact and the combination function between high temperature gas and electrode. This leads to the instability of plasma arc, weak compression effect, and weak cutting penetration ability that cutting cannot be proceeded. If ΔL_y is too big, the arc is so unstable that the cutting ability is weakened. The electrode end should be placed within siphoning zone of gas current under a relative vacuum condition, and it will difficult to damage electrode by burning, as well as this is beneficial for compression of arc. ΔL_y is about 2-4mm.

● The distance between the nozzle and the work piece (d)

If the d is too big, the blow power of plasma arc for molten metal decreases, so does the cutting ability, and the burr on the bottom increases, meanwhile the instability of the arc increases. However, if the d is too small, it increases the possibility of short circuit between the nozzle and the work piece. Usually d should be as small as possible on condition that no short circuit is caused between nozzle and work piece. The d under normal cutting of air plasma is usually 2~5mm. The work piece can also contact with the nozzle during air plasma cutting, that is, the nozzle glide on the surface of the work piece. This cutting method is called contact cutting, and the cutting thickness is the half as the ordinary cutting.

- **Open circuit voltage**

The power source with high open circuit voltage is required for cutting thick workpiece. The open circuit voltage is related with air type, for example, by using argon the open circuit voltage may be lower, while it is higher by using air, nitrogen, hydrogen.

- **Cutting speed**

The cutting speed is related with many parameters. The main parameters determining cutting speed include workpiece thickness, cutting current, air flux and nozzle aperture. A proper drag is allowed during cutting. The cutting speed should be increased as much as possible, but the incision quality must be guaranteed.

2. Eliminate the cutting burr

- **The characteristics of the incision burr**

The ordinary cutting surface is smooth and clean, but if the parameter selection is not suitable, and electrode centering is not good, then burr may be formed on the cutting surface.

Slag is formed by molten metal and its oxide which is adhesive to the bottom edge of incision and solidified. The reason for forming this slag is that the molten metal adhesive strength is bigger than the gravity and blow strength of metal oxide.

When cutting the alloy steel, the molten metal is difficult to be blown away because of its bad fluidity, in addition, the alloy steel have bad thermal conductivity, the incision bottom is over-heated easily, the left molten metal and incision bottom melts into one, thereby the irremovable and tough burr is formed.

On the contrary, the incision bottom is difficult to be melted together with molten metal, and the burr formed under incision is come off easily.

- **The factors affecting the forming of burr**

- The fluidity of the molten metal is not good, when the power is too small or the plasma arc compression effect is not good, the temperature of molten metal during the cutting process is low, fluidity is weak, even if the air current blow force is strong, it is still difficult to blow away the metal completely, so the burr is formed.
- □ When cutting the thick plate, the burr is caused by the drag of overlarge cutting seam. During the cutting process, the heat received by different parts of metal is different, the heat on the upper incision is larger than that of the lower incision, so the upper part melting speed is faster than that of lower part, thereby a distance between them is formed, it is called drag L of cutting seam. The drag size is related to plasma arc shape and cutting speed. When the flame is short while the cutting speed is too fast, drag L increases, so the vertical and horizontal blow force of the arc is formed, the vertical one helps to blow away the molten metal, while the horizontal one makes the molten metal flow backward along with incision bottom, this over-heated metal will melt parts of the bottom metal again, then the burr is formed when they cool down and melt together.

- □ The burr is caused by overheat bottom. When the cutting speed is too slow, but the incision bottom is so over-heated that it melts, the liquid metal flows to bottom metal and combines into one which makes the difficulty to blow away molten metal by air current, and then the burr is formed.
- □ The air current blow force is not enough. When cutting with plasma, the arc blow force consists of the air current blow force and the arc electromagnetic force, the air current blow force acts the main function. If the air current blow force is not strong enough, it cannot ensure all the burr is flown away, then the burr is formed.

● **The measurement to eliminate burr**

- □ Ensure the centering between electrode and nozzle precisely, so that the compression of the plasma arc is not damaged, the concentration of flame and cutting capacity can be guaranteed.
- □ Enough power to ensure the fluidity of molten metal, as well as increase the stability of the cutting speed and operation. This makes it possible to adopt large air flux to enlarge the air blow force, and beneficial for eliminating burr.
- Adjust suitable air flux and cutting speed. If the air flux is too small, the blow force is not enough, while if too big, the plasma arc will be shorten, the incision will be “V” shape, the drag enlarge. The burr can be formed under both conditions. When cutting speed is too slow, the incision is large and rough, the bottom is easy to be over-heated, while the cutting speed is fast, the drag is enlarged, this is not beneficial for eliminating burr.
- So under certain circumstance, there exists a proper selection range for air flux and cutting speed.

● **Diminish the cutting surface slanting and rounding problem**

The incision surface is a little slant and the upper side is a little round during cutting with air plasma. Though the slanting range is acceptable during the cutting process, in order to improve the cutting quality, people begins to pay attention to this problem. Usually slowing down the cutting speed properly can avoid the slanting, but this may enlarge the effect zone and incision width, as well as decrease the production capacity, so this measurement is not wildly used. Recently, people can avoid the slanting by improving the nozzle structure, this is called super cutting method. By adopting multi-hole nozzle during the cutting process, the air current from the small hole is parallel with that from the main hole, this can avoid the dispersing of the plasma flame on metal top, and then a parallel incision, square upper side and no metal slag seam on the lower side is obtained.

◆ **Troubleshooting & repair**

- 1、 **If there is trouble caused by high voltage in the machine, a professional electrician or serviceman of our company is required to repair it.**
- 2、 **Please check following first when there is trouble.**
 - 1) The three-phase power should be $380\pm 40\text{VAC}$, check if it misses phase or voltage fluctuation exceeds its required range of power supply;
 - 2) Check if the supply abnormality indicator lamp is ON. If it is ON, check if the three-phase power switch of distribution box is damaged, and if the fuse and the machine power wire are well equipped. Otherwise it will cause phase missing or bad contact, which makes the machine work abnormally;
 - 3) Check if the torch switch and its wire are damaged or short-circuit, and if the nozzle and

- electrode are damaged;
- 4) If the control plug is connected mistakenly after user exchanging a different torch from another manufacturer, please proceed the checking as per “torch connection” mentioned in instruction manual.
 - 5) Check if the cutting ground wire is well connected;
 - 6) Check if the water in compressed air filter fixed at the back of machine is drained regularly;
 - 7) Check if the gas pressure indicator lamp on the panel is ON. If it is not ON, check if compressed gas pipe is well connected , and if the gas pressure is normal. When the gas pressure is less than 0.3Mpa, the lamp is not ON.
 - 8) When the water cooling torch is applied, check if the water pressure indicator lamp on panel is ON. If it is not ON, check if the cooling water current is normal.
 - 9) Check if the overheat indicator lamp on panel is ON. If yes, check if the temperature relay on the radiator is damaged or not.
 - 10) Open the machine top to check if the lead-typed fuse next to the control transformer has been fused;

Ordinary trouble and repair as following diagram

Trouble	Reasons	Solutions
1. When the power is switched on, the lamp and the digital meter are not ON.	1.Three-phase power misses phase 2.Supply power switch is damaged 3.Power control fuse 3A is broken	1.Check three-phase power source 2.Change power switch 3.Change power control fuse
2. Supply abnormality indicator lamp is ON without arc striking	1. Three-phase power misses phase 2. Three-phase power is overload under voltage	Check three-phase power source to ensure the supply voltage accords with the supply requirements.
3. No arc striking or arc breaking during cutting. Overheat indicator lamp is ON.	1. The ambient temperature is too high. 2. When cutting, cooling fan rotates slowly or do not rotate, so the cooling effect is weak. 3. Temperature relay is damaged	1. Let the cutter rest for a while, and will come to work normally later. 2. Check fan power source or change cooling fan 3. Change temperature relay
4. It cannot start. Gas pressure lamp is not ON.	1. No gas pressure 2. The gas supply pressure is too low 3. LGK AP1 is damaged	1. connect the gas source 2. Adjust gas supply pressure 3. change LGK AP1..
5. no arc striking, cutting indicator lamp, gas pressure lamp are ON, and power supply abnormality indicator lamp and overheat lamp are not ON.	1. Cutting ground wire is not well connected. 2. Gas pressure is too high. 3. Torch electrode and nozzle are badly broken. 4. Torch electrode and arc striking wire is short circuit, which cause the damage of torch. 5. HF board is damaged.	1. Connect the cutting ground wire well 2. Lower the gas supply pressure 3. Change the electrode and nozzle 4. Change the torch 5. Change HF board
6. Weak cutting quality	1. Gas pressure is too high or too low. 2. The Air filter regulator cup is filled. 3. Workpiece is too thick	1. Adjust gas pressure 2. Water draining regularly 3. The thickness of workpiece should be within the quality cutting range. 4. Change electrode and nozzle

	<ul style="list-style-type: none"> 4. Torch electrode and nozzle are broken 5. Plasma arc is not perpendicular to the workpiece 6. Cutting speed is too fast or too slow 	<ul style="list-style-type: none"> 5. Adjust torch angle 6. Adjust cutting speed
7 . Electrode and nozzle work life is very short.	<ul style="list-style-type: none"> 1. Gas pressure is too low 2. Nozzle is too close to workpiece. The distance is less than 2mm. 3. nozzle aperture is small, and not matched with applied current. 4. electrode and nozzle is under quality problem. 5. the torch bought by user himself is under quality problem. 	<ul style="list-style-type: none"> 1. Adjust gas pressure 2. The distance should be within 2mm to 5mm 3. select a proper nozzle matched with applied current. 4. change a good quality electrode and nozzle. 5. buy a good quality torch.
8.no arc striking, and guiding arc spraying out, but there is high frequency.	<ul style="list-style-type: none"> 1.fast recovery diode of secondary rectifying is damaged. 2.current-limiting resistor R6,R7,R8 of guiding arc is damaged. 3.high frequency leakage in cutter output circuit. 	<ul style="list-style-type: none"> 1. change fast recovery diode under same model. 2. check and change the damaged current-limiting resistor of guiding arc. 3. check leakage point, and strengthen insulation function.
9.supply power trips	<ul style="list-style-type: none"> 1.three phases rectifier is damaged. 2.IGBT module is damaged. 3.other components in main control circuit is damaged. 	<ul style="list-style-type: none"> 1.change a three phases rectifier under same model. 2.change IGBT module under same model. 3.check and change the damaged components.

If the troubles cannot be resolved, please inform our local agent of the specific problems or contact our service deptt. directly.

